

EN OWNER'S MANUAL /
Instructions for Assembly '7 Ft Garbage Bin Shed'
Size 7Ft x 3Ft / 2.1 m x 0.9 m
Ver: 0.0

FR MANUEL D'INSTRUCTION/
Instructions pour l'Assemblage '7 Pieds Abri poubelles'
Dimension 7Pieds x 3Pieds / 2.1 Mètre x 0.9 Mètre
Ver: 0.0

DE Benutzerhandbuch /
Montageanleitung '7 Ft Mülltonnen Box'
Größe: 7Ft x 3Ft / 2.1 m x 0.9 m
Ver: 0.0

ES MANUAL DEL PROPIETARIO /
Instrucciones de montaje '7 Pies Cobertizo cubos de basura'
Tamaño 7Pies x 3Pies / 2.1 Metros x 0.9 Metros
Ver: 0.0

PT MANUAL DO PROPRIETARIO/
Instruções de montagem '7 pés Abrigo de Caixa de Lixo'
Tamanho 7pés x 3pés / 2.1 Metro x 0.9 Metro
Ver:0.0

NL Gebruiksaanwijzing voor eigenaar/
Instructies voor bouw '7 Voet Containerberging'
Maat 7 voet x 3 voet / 2.1 Meter x 0.9 Meter
Versie: 0.0

CS Příručka uživatele /
Návod k montáži '7 Stopy Přístřešek na popelnice'
Velikost 7 Stopy x 3 Stopy / 2.1 Metr x 0.9 Metr
Verze : 0.0

SK NÁVOD PRE UŽÍVATEĽA /
Návod na zloženie '7 Stopa Prístrešok na popolnice'
Velkost' 7 Stopa x 3 Stopa / 2.1 m x 0.9 m
Pozri: 0.0

SL PRIROČNIK ZA LASTNIKA /
Navodila za montažo '7 Čevljev Zavetišče za kante za smeti'
Velikost 7 Čevljev x 3 Čevljev / 2.1 Metrov x 0.9 Metrov
Razl: 0.0

HR Gazdinski Priručnik /
Instrukcije za skupštine '7 Stopalo Menedék kukáknak'
Veličina 7 Stopalo x 3 Stopalo/ 2.1 Metar x 0.9 Metar
Ver: 0.0

HU FELHASZNÁLÓI KÉZIKÖNYV /
Útmutató az összeszereléshez '7 Láb Csomagtartó hulladékartályokhoz'
7 Láb x 3 Láb / 2.1 Méter x 0.9 Méter
0.0 verzió

SV ÄGARENS MANUAL/
Monteringsinstruktioner för '7 Fot Soporna Bin skjul'
Storlek 7 fot x 3 fot / 2.1 m x 0.9 m
Version: 0.0

IT MANUALE DEL PROPRIETARIO /
Istruzioni per l'assemblaggio '7 Piedi Baule Per Contenitori Porta Rifiuti'
Dimensione 7 Piedi x 3 Piedi / 2.1 Metri x 0.9 Metri
Versione 0.0

PL PODRĘCZNIK UŻYTKOWNIKA /
Instrukcja montażu '7 Stopy Rzucić Bin śmieci'
Wymiary 7 Stopy x 3 Stopy / 2.1 Metr x 0.9 Metr
Wersja: 0.0

RO MANUAL DE UTILIZARE /
Instrucțiuni de asamblare '7 Picioare Gunoi Bin vărsat'
Mărimē 7 Picioare x 3 Picioare / 2.1 Metri x 0.9 Metri
Ver: 0.0

BG РЪКОВОДСТВО ЗА ПРИТЕЖАТЕЛЯ /
Инструкции за сглобяване '7 Фута Приют за боклук'
Размер 7 Фута x 3 Фута / 2.1 Метра x 0.9 Метра
Версия: 0.0

TR KULLANIM KILAVUZU /
Montaj Talimatları '7 Fit çöp kutusu dökēn'
7 Fit x 3 Fit / 2.1 m x 0.9 m
Sürüm: 0.0

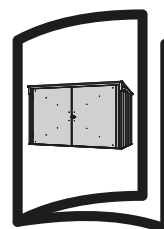
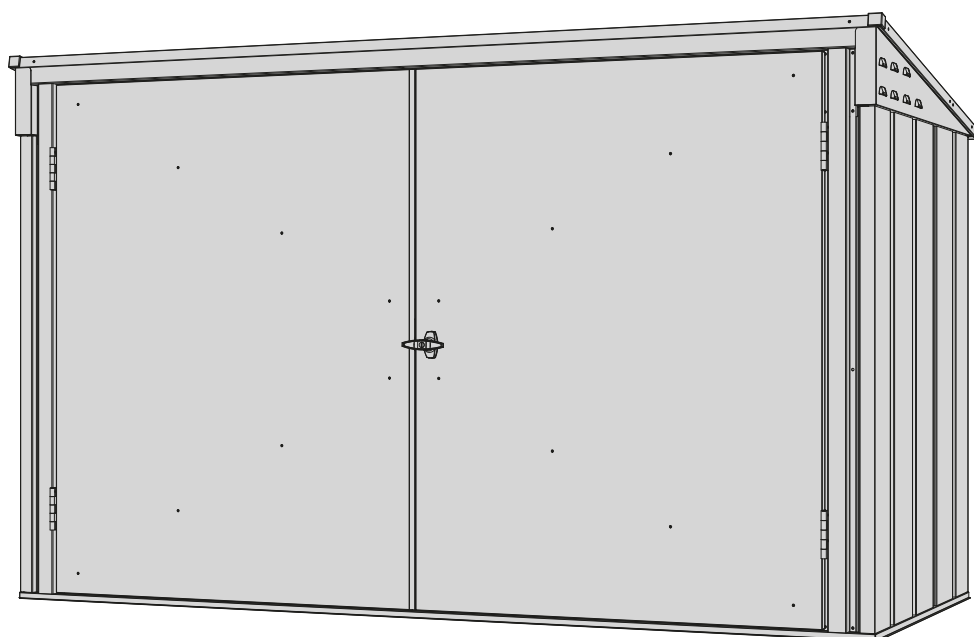

EN

Building Dimensions :

Approximate Size	Storage		Exterior Dimension				Interior Dimension		Door Opening		
	Area	Volume	Base Dimension		Roof Edge to Edge		Wall to Wall				
			inch	cm	inch	cm	inch	cm	inch	cm	
7 Ft x 3 Ft	19 1/2 Sq. Ft	71 1/2 Cu.Ft	Width	83 3/8	211.7	84 3/8	214.3	81 3/4	207.7	73 5/8	187
2.1 m x 0.9 m	1.81 Sq.m	2.02 Cu.m	Depth	36	91.5	37 3/4	96.0	34 1/2	87.5		
			Height			51 3/8	130.6	43 7/8	111.4	47	119.3

Snow load tested max. 12lbs / sq.foot (As per IP Standard).

"We recommend to clear snow from the Roof top after each Snowfall."

A snow depth of more than 10 cm can become hazardous!

FR

Dimensions du bâtiment :

Taille approximative	Stockage		Dimension extérieure				Dimension intérieure		Ouverture de porte		
	Secteur	Volume	Dimension de base		Toit de bord au bord		Mur à mur				
			pouce	cm	pouce	cm	pouce	cm	pouce	cm	
7 Pieds x 3 Pieds	19 1/2 Carré pieds	71 1/2 Pieds cube	Largeur	83 3/8	211.7	84 3/8	214.3	81 3/4	207.7	73 5/8	187
2.1 Mètre x 0.9 Mètre	1.81 Mètre carré	2.02 Mètre cube	Profondeur	36	91.5	37 3/4	96.0	34 1/2	87.5		
			Hauteur			51 3/8	130.6	43 7/8	111.4	47	119.3

Charge de neige testé max. 12lbs / Carré pieds (conformément à la norme IP).

"Nous recommandons d'enlever la neige du Toit après chaque Enneigement."

Une épaisseur de neige de plus de 10 cm peut devenir dangereux!

DE

Gebäude Abmessung:

Ungefähre Größe	Speicher		Außen Abmessung				Innen Abmessung		Türöffnung		
	Bereich	Volumen	Fundament Abmessung		Dach Kante bis Kante		(von Wand zu Wand)				
			inch	cm	inch	cm	inch	cm	inch	cm	
7 Ft x 3 Ft	19 1/2 Sq. Ft	71 1/2 Cu.Ft	Breite	83 3/8	211.7	84 3/8	214.3	81 3/4	207.7	73 5/8	187
2.1 m x 0.9 m	1.81 Sq.m	2.02 Cu.m	Tiefe	36	91.5	37 3/4	96.0	34 1/2	87.5		
			Höhe			51 3/8	130.6	43 7/8	111.4	47	119.3

Schneelast max. getestet. 12lbs /sq.Foot (gem. Standard IP).

"Wir empfehlen liegenden Schnee nach jedem Schneefall vom Dach abzuräumen."

Eine Schneetiefe von mehr als 10 cm kann gefährlich werden!

ES

Medidas de la caseta:

El Tamaño a proximado	Área de almacenaje		Dimensión exterior				Dimensión interior		Abertura de la puerta		
	Área	Volumen	Dimensión de la base		Borde del tejado al borde		pared a pared				
			Pulgada	cm	Pulgada	cm	Pulgada	cm	Pulgada	cm	
7 Pies x 3Pies	19 1/2 Pies cuadrados	71 1/2 Pies Cúbicos	Anchura	83 3/8	211.7	84 3/8	214.3	81 3/4	207.7	73 5/8	187
2.1 Metros x 0.9 Metros	1.81 Metros cuadrados	2.02 Metros Cúbicos	Profundidad	36	91.5	37 3/4	96.0	34 1/2	87.5		
			Altura			51 3/8	130.6	43 7/8	111.4	47	119.3

Carga de nieve probado max. 12lbs / Pies cuadrados (según el estándar de IP).

"Se recomienda limpiar la nieve de la azotea después de cada nevada."

Una profundidad de nieve de más de 10 cm puede llegar a ser peligrosa!

PT

Área de Construção:

Dimensão aproximada	Área de Arrumação		Dimensão Exterior				Dimensão Interior		Abertura da Porta		
	Área	Volume	Dimensão da base		Amplitude do Telhado		(Parede a Parede)				
			Polegada	centímetro	Polegada	centímetro	Polegada	centímetro	Polegada	centímetro	
7 pés x 3 pés	19 1/2 Pies quadrado	71 1/2 Pies cúbico	Comprimento	83 3/8	211.7	84 3/8	214.3	81 3/4	207.7	73 5/8	187
2.1 Metro x 0.9 Metro	1.81 Metro quadrado	2.02 Metro cúbico	Profundidade	36	91.5	37 3/4	96.0	34 1/2	87.5		
			Altura			51 3/8	130.6	43 7/8	111.4	47	119.3

Carga de neve testado max. 12lbs / Pies quadrado (conforme padrão IP).

"Recomendamos limpar a neve do topo do telhado após cada queda de neve."

Uma profundidade de neve de mais de 10 cm pode tornar-se perigosa!

NL

Gebouw afmeting:

Benadering Maat	Opslag		Buitenkant afmeting				Binnenkant afmeting		Deur opening		
	Gebied	Volume	Basis afmeting		Dakrand tot rand		Muur tot muur				
			inch	cm	inch	cm	inch	cm	inch	cm	
7 Voet x 3 Voet	19 1/2 Vierkante voet	71 1/2 Kubieke voet	Wijde	83 3/8	211.7	84 3/8	214.3	81 3/4	207.7	73 5/8	187
2.1 m x 0.9 m	1.81 Vierkante meter	2.02 Kubieke meter	Diepte	36	91.5	37 3/4	96.0	34 1/2	87.5		
			Hoogte			51 3/8	130.6	43 7/8	111.4	47	119.3

Sneeuw belasting getest max. 12lbs / Vierkante voet (volgens het standaard IP-).

“We raden aan sneeuw uit het dak te verwijderen na elke sneeuwval.”

Een sneeuwdiepte van meer dan 10 cm kan gevaarlijk worden!

CS

Budova rozměr

Přibližné rozměry	Skladování		Vnější rozměr				Vnitřní rozměr		Otevírání dveří		
	Plocha	Objem	Základní rozměr		Na okraj střechy edge		Zdi ke zdi				
			inch	cm	inch	cm	inch	cm	inch	cm	
7 Stopy x 3 Stopy	19 1/2 Čtvereční Stopy	71 1/2 Krychlový Stopy	Šířka	83 3/8	211.7	84 3/8	214.3	81 3/4	207.7	73 5/8	187
2.1 Metr x 0.9 Metr	1.81 Čtvereční metr	2.02 Krychlový Metr	Hloubka	36	91.5	37 3/4	96.0	34 1/2	87.5		
			Výška			51 3/8	130.6	43 7/8	111.4	47	119.3

Zkouška zatížení sněhu max. 12lbs / Čtvereční Stopy (podle normy IP).

“Doporučujeme odstranit sníh ze střešního krytu po každém sněžení.”

Možná hloubka sněhu větší než 10 cm může být nebezpečná!

SK

Stavebné rozmer

Približné veľkosti	Sklad		Vonkajší rozmer				Interiér rozmer		Otvorenie dverí		
	Priestor	Objem	Base rozmer		Strešné okraja k okraju		Zdi k múru				
			inch	cm	inch	cm	inch	cm	inch	cm	
7 Stopa x 3 Stopa	19 1/2 Stopa štvorcový	71 1/2 Stopa kubický	Šírka	83 3/8	211.7	84 3/8	214.3	81 3/4	207.7	73 5/8	187
2.1 m x 0.9 m	1.81 Meter štvorcový	2.02 Meter kubický	Hĺbka	36	91.5	37 3/4	96.0	34 1/2	87.5		
			Výška			51 3/8	130.6	43 7/8	111.4	47	119.3

Testovanie zaťaženia snehu max. 12lbs / Stopa štvorcový (podľa IP štandardu).

“Odporúčame odstrániť sneh zo strechy po každej snehu.”

Z hĺbky snehu väčšej ako 10 cm sa môže stať nebezpečné!

SL

Zidanje obseg

približno velikost	Skladiščenje		zunanji obseg				notranji obseg		vrata predrtina		
	Območje	Prostornina	osnova obseg		streha rob v rob		obdati obzidati				
			cola	cm	cola	cm	cola	cm	cola	cm	
7 Čevljev x 3 Čevljev	19 1/2 Kvadratnih Čevljev	71 1/2 Kubičnih Čevljev	širina	83 3/8	211.7	84 3/8	214.3	81 3/4	207.7	73 5/8	187
2.1 Metrov x 0.9 Metrov	1.81 Kvadratnih Metrov	2.02 Kubičnih Metrov	globina	36	91.5	37 3/4	96.0	34 1/2	87.5		
			višina			51 3/8	130.6	43 7/8	111.4	47	119.3

Snow obremenitev testiran max. 12lbs / Kvadratnih Čevljev (po standardu IP).

“Priporočamo, da počistite sneg z vrha strehe po vsakem sneženju.”

Z globino snega več kot 10 cm lahko postane nevarno!

HR

Zgrada dimenzija

Približno određena mjera	Skladištenje		Vanjski dimenzija				Interijer dimenzija		Vrata Open		
	Područje	Svezak	Temeljiti dimenzija		Krov rub to rub		Zidni to zidni				
			inch	cm	inch	cm	inch	cm	inch	cm	
7 Stopalo x 3 Stopalo	19 1/2 Četvornih Stopalo	71 1/2 Kubni Stopalo	širina	83 3/8	211.7	84 3/8	214.3	81 3/4	207.7	73 5/8	187
2.1 Metar x 0.9 Metar	1.81 Četvornih Metar	2.02 Kubni Metar	dubina	36	91.5	37 3/4	96.0	34 1/2	87.5		
			visina			51 3/8	130.6	43 7/8	111.4	47	119.3

Testirano opterećenje max. 12lbs / Četvornih Stopalo (prema IP standardu).
 “Preporučujemo čišćenje snijega s vrha krova nakon svakog snijega.”
 Nema dubine snijega veće od 10 cm može biti opasna!

HU

Építési dimenzió

Hozzávetőleges mérete	Tárolás		Külső méret				A belső dimenzió		Ajtónyitás		
	Terület	Mennyiség	Alap dimenzió		Tető élétől él		A fal és a fal				
			Hüvelyk	cm	Hüvelyk	cm	Hüvelyk	cm	Hüvelyk	cm	
7 Láb x 3 Láb	19 1/2 Négyzet Láb	71 1/2 Köb Láb	Szélesség	83 3/8	211.7	84 3/8	214.3	81 3/4	207.7	73 5/8	187
2.1 Méter x 0.9 Méter	1.81 Négyzet méter	2.02 Köbméter	Oldalmagasság	36	91.5	37 3/4	96.0	34 1/2	87.5		
			Magasság			51 3/8	130.6	43 7/8	111.4	47	119.3

A terhelés max. 12lbs / Négyzet Láb (IP-szabvány szerint).
 “Javasoljuk, hogy minden hóesést követően tisztítsa meg a havat a tetőtől.”
 A 10 cm-nél hosszabb hóvastagság veszélyessé válhat!

SV

Byggnadsdimensioner:

Ungefärlig storlek	Lager		Yttre dimensioner				Inre dimensioner		Dörröppning		
	Area	Volym	Basdimensioner		Tak kant till kant		Vägg till vägg				
			Tum	cm	Tum	cm	Tum	cm	Tum	cm	
7 fot x 3 fot	19 1/2 kvadrat fot	71 1/2 kubik fot	Bredd	83 3/8	211.7	84 3/8	214.3	81 3/4	207.7	73 5/8	187
2.1 m x 0.9 m	1.81 kvadratmeter	2.02 kubik meter	Djup	36	91.5	37 3/4	96.0	34 1/2	87.5		
			Höjd			51 3/8	130.6	43 7/8	111.4	47	119.3

Snow last testas max. 12lbs / kvadrat fot (enligt IP-standard).
 “Vi rekommenderar att klara snö från taket efter varje snöfall.”
 Ett snödjup på mer än 10 cm kan bli farligt!

IT

Dimensioni di Costruzione:

Dimensione approssimativa	Deposito		Dimensione Esterna				Dimensioni Interne		Apertura della Porta		
	Area	Volume	Dimensione della Base		Soffitto da Lato a Lato		Da Muro a Muro				
			Inches	Centimetri	Inches	Centimetri	Inches	Centimetri	Inches	Centimetri	
7 Piedi x 3 Piedi	19 1/2 Piedi Quadrati	71 1/2 Piedi Cubici	Ampiezza	83 3/8	211.7	84 3/8	214.3	81 3/4	207.7	73 5/8	187
2.1 Metri x 0.9 Metri	1.81 Metri Quadrati	2.02 Metri Cubici	Profondità	36	91.5	37 3/4	96.0	34 1/2	87.5		
			Altezza			51 3/8	130.6	43 7/8	111.4	47	119.3

Snow carico testato max. 12lbs / Piedi Quadrati (come per IP standard).
 “We consigliamo di eliminare la neve dalla tetto del tetto dopo ogni nevicata.”
 Una profondità di neve di oltre 10 cm può diventare pericolosa!

PL

Wymiary budowlane:

Przybliżone wymiary	Magazynowa		Wymiary zewnętrzne				Wymiary wewnętrzne		Otwieranie drzwi		
	Powierzchnia	Kubatura	Wymiary fundamentów		Dachu od krawędzi do krawędzi		od ściany do ściany				
			Cal	cm	inch	cm	inch	cm	inch	cm	
7 Stopy x 3 Stopy	19 1/2 Stopy kwadratowy	71 1/2 Stopy sześcienny	Szerokość	83 3/8	211.7	84 3/8	214.3	81 3/4	207.7	73 5/8	187
2.1 Metr x 0.9 Metr	1.81 Metr kwadratowy	2.02 Metr sześcienny	Głębokość	36	91.5	37 3/4	96.0	34 1/2	87.5		
			Wysokość			51 3/8	130.6	43 7/8	111.4	47	119.3

Testowane obciążenie śniegiem max. 12lbs (zgodnie ze standardem IP).
 “Po każdym opadzie śniegu zalecamy usuwanie śniegu z dachu”.
 Grubość śniegu powyżej 10 cm może być niebezpieczna!

RO

Cladirea dimensiuni

Dimensiunea aproximativa	Depozitarea		Dimensiunea exterioara				Dimensiunea interne		deschiderea usii		
	Suprafata	Volumul	Baza dimensiuni		Acoperisul marginea la marginea		perete in perete				
			inch	cm	inch	cm	inch	cm	inch	cm	
7 Picioare x 3 Picioare	19 1/2 Picioare pătrați	71 1/2 Picioare cubi	Latimea	83 3/8	211.7	84 3/8	214.3	81 3/4	207.7	73 5/8	187
2.1 Metri x 0.9 Metri	1.81 Metri pătrați	2.02 Metri cubi	Adancimea	36	91.5	37 3/4	96.0	34 1/2	87.5		
			Inaltimea			51 3/8	130.6	43 7/8	111.4	47	119.3

Rezultatea de încărcare maximă testată. 12lbs / Picioare pătrați (conform standardului IP).
 “Vă recomandăm să eliminați zăpada din partea superioară a acoperișului după fiecare zăpadă.”
 O adâncime de zăpadă mai mare de 10 cm poate deveni periculoasă!

BG

Сградата измерение

Ориентировачна размер	Съхранение		Външно измерение				Министърът на вътрешните измерение		Вратата отваряне		
	Площ	Обем	База измерение		Покрив край до край		Стената на стената				
			Инча	Сантиметра	Инча	Сантиметра	Инча	Сантиметра	Инча	Сантиметра	
7 Фута x 3 Фута	19 1/2 Квадратни Фута	71 1/2 Кубични Фута	Ширина	83 3/8	211.7	84 3/8	214.3	81 3/4	207.7	73 5/8	187
2.1 Метра x 0.9 Метра	1.81 Квадратни Метра	2.02 Кубични Метра	Дълбочина	36	91.5	37 3/4	96.0	34 1/2	87.5		
			Височина			51 3/8	130.6	43 7/8	111.4	47	119.3

Тестване на тежестта на снемане макс. 12lbs / Квадратни Фута (според IP Стандарт).
 “След всеки снеговалеж препоръчваме да изчистите снега от покрива на покрива.”
 Дълбочина на снега повече от 10 см може да стане опасна!

TR

İnşaat boyutu

Tahmini büyüklüğü	Depo		Diş boyutlar				İç boyutu		Kapı açılması		
	Alan	Hacim	Temel boyutundaki		sertliği için harekete		Duvardan duvara				
			İnç	Sanтимetre	İnç	Sanтимetre	İnç	Sanтимetre	İnç	Sanтимetre	
7 Fit x 3 Fit	19 1/2 Metre Fit	71 1/2 Kübik Fit	Genişlik	83 3/8	211.7	84 3/8	214.3	81 3/4	207.7	73 5/8	187
2.1 m x 0.9 m	1.81 Metrekare	2.02 Kübik metre	Derinlik	36	91.5	37 3/4	96.0	34 1/2	87.5		
			Yükseklik			51 3/8	130.6	43 7/8	111.4	47	119.3

Saat yükü test max. 12lbs / Metre Fit (IP Standardına göre).
 “Her Kar yağışı sonrasında Çatı üstten kar temizlemenizi öneririz.”
 Kar derinliği 10 cm'den fazla tehlikeli olabilir!

EN Tools You Will Need

- | | |
|----------------------------------|---------------------|
| 1. Cordless Drill - Philips Head | 6. Tape Measure |
| 2. Screwdriver - Philips Head | 7. Hand Gloves |
| 3. Carpenters Square | 8. Eye Protector |
| 4. Adjustable Spanner | 9. Box Spanner-7 mm |
| 5. Level - 3ft. | |

FR Outils dont vous aurez besoin

- | | |
|-------------------------------------|--------------------------------|
| 1. Perceuse sans fil – Tête Philips | 6. Ruban à mesurer |
| 2. Tournevis - Tête Philips | 7. Gants |
| 3. Équerre du Menuisier | 8. Protecteur des Yeux |
| 4. Clé à molette | 9. Clé de serrage de boîte-7mm |
| 5. Niveau - 3ft. | |

DE Benötigte Werkzeuge

- | | |
|---|------------------------|
| 1. Akku-Bohrschrauber - Kreuzschlitzbit | 6. Maßband |
| 2. Kreuzschlitz-Schraubenzieher | 7. Handschuhe |
| 3. Winkelmaß | 8. Schutzbrille |
| 4. Verstellbarer Schraubenschlüssel | 9. Kasten- |
| 5. Wasserwaage – 1 m | Schraubenschlüssel-7mm |

ES Herramientas necesarias para el montaje

- | | |
|--|--------------------------------|
| 1. Atornillador eléctrico con cabeza estrella/ Philips | 6. Cinta métrica |
| 2. Destornillador estrella / Philips | 7. Use guantes de seguridad |
| 3. Gafas protectoras | 8. Escuadra |
| 4. Llave inglesa | 9. Llave de tuerca de caja-7mm |
| 5. Nivel de 1m | |

PT Ferramentas que irá precisar

- | | |
|------------------------------------|-------------------------|
| 1. Cordless Berbequim | 6. Fita Métrica |
| 2. Chave de fenda – cabeça estrela | 7. Luvas |
| 3. Esquadro de carpinteiro | 8. Protector Ocular |
| 4. Chave inglesa ajustavel | 9. Chave de parafuso de |
| 5. 3ft. Nivel | caixa-7mm |

NL Gereedschappen die u nodig zult hebben

- | | |
|---|--------------------|
| 1. Snoerloze boormachine met gekruiste kop | 6. Meetlint |
| 2. Snoerloze schroevendraaier met gekruiste kop | 7. Handschoenen |
| 3. Winkelhaak | 8. Oogbescherming |
| 4. Verstelbare moersleutel | 9. Vak spanner-7mm |
| 5. Waterpas | |

CS Budete potřebovat toto nářadí

- | | |
|---------------------------------|--------------------------|
| 1. Bezdrátová vrtačka - Philips | 6. Svinovací metr |
| 2. Vrták - Philips | 7. Rukavice |
| 3. Tesařské náměstí | 8. Ochranné brýle |
| 4. Nastavitelný klíč | 9. Krabicový klíč - 7 mm |
| 5. Vodováha - 3ft. | |

SK Nástroje, ktoré budete potrebovať

- | | |
|--------------------------------------|----------------------|
| 1. Bezdrôtová vrtačka - Philips Head | 6. Meter |
| 2. Šraubovák – Philips Head | 7. Rukavice |
| 3. Stolársky meter | 8. Ochranu na oči |
| 4. Nastavitelný kľúč | 9. Kľúčový kľúč 7 mm |
| 5. Zdvihák – 3 stopy. | |

SL Orodje, ki ga boste potrebovali

- | | |
|------------------------------------|--------------------|
| 1. Brezžična vrtalna- glava Philip | 6. Merilni trak |
| 2. Vijačnik-glava Philip | 7. Rokavice |
| 3. Mizarski kvadrat | 8. zaščitna očala |
| 4. Nastavljiv Spanner | 9. Polje kľuč-7 mm |
| 5. Nivelirka - 0,91 m | |

HR Alati, Trebat će Vam

- | | |
|--------------------------------------|-----------------------------|
| 1. Bežični Svrđlo – Philips Voditelj | 6. Traka Divizor |
| 2. Vijak Vozač - Philips Voditelj | 7. Ručni Rukavice |
| 3. Drvodjelac Četverokut | 8. Oko Zaštitnik |
| 4. Podesivi kľuč | 9. Kutija za kľučeve - 7 mm |
| 5. Razina – 3 stoplo. | |

HU A szükségesszerszámok

- | | |
|---------------------------------------|------------------|
| 1. Vezeték nélküli fúró – csillagfejű | 6. Mérőszalag |
| 2. Csavarhúzó – csillagfejű | 7. Kesztyűk |
| 3. Ácsderékszög | 8. Szemvédő |
| 4. Állítható csavarkulcs | 9. Csőkulcs-7 mm |
| 5. Vízszintmérő. | |

SV Verktyg du kommer att behöva

- | | |
|--------------------------------------|------------------------|
| 1. Sladdlös bormaskin - Philips borr | 6. Måttband |
| 2. Skruvmejsel - krysshuvud | 7. Verktygshandskar |
| 3. Vinkelhake | 8. Ögonskydd |
| 4. Skiftnyckel | 9. Box skiftnyckel-7mm |
| 5. vattenmått - 3fot. | |

IT Gli Attrezzi di cui Avrai Bisogno

- | | |
|--|-----------------------------|
| 1. Trapano senza fili – Punta a stella | 6. Metro a Nastro |
| 2. Cacciavite – Punta a stella | 7. Guanti |
| 3. Squadra metallica | 8. Protezione per gli occhi |
| 4. Chiave Inglese | 9. Chiave a tubo - 7mm |
| 5. Livello – 3 piedi | |

PL Potrzebne narzędzia

- | | |
|--|----------------------|
| 1. Bezprzewodowa wkrętarzka – krzyżakowa | 6. Taśma miernicza |
| 2. Śrubokręt krzyżakowy | 7. Rękawice ochronne |
| 3. Kałownik stolarski | 8. Okulary ochronne |
| 4. Klucz nastawny | 9. Klucz-Box 7mm |
| 5. Poziomica – 91,4 cm | |

RO Instrumentele de care aveți nevoie

- | | |
|-----------------------------------|--------------------------|
| 1. Șurubelniță – cap Philips | 6. Ruletă de măsurat |
| 2. Mașină de găurit – cap Philips | 7. Mănuși de protecție |
| 3. Echer de dulgherie | 8. Protecție pentru ochi |
| 4. Cheie reglabilă | 9. Caseta Spanner-7mm |
| 5. Nivel - 3ft. | |

BG Инструменти, които ще ви трябват

- | | |
|---|------------------------|
| 1. Безжична бормашина - с глава Philips | 6. Рулетка |
| 2. Отвертка – с глава Philips | 7. Ръкавици |
| 3. Прав ъгъл | 8. Маска за очите |
| 4. Регулируем гаечен кľуч | 9. Гаечная коробка-7mm |
| 5. Нивелир – 1 м (3ft). | |

TR İhtiyaç duyacağınız aletler

- | | |
|------------------------------------|------------------------|
| 1. Kablosuz Matkap- Philips Başlık | 6. Mezura |
| 2. Tornavida-Philips Başlık | 7. Eldiven |
| 3. Marangoz gönyesi | 8. Göz Koruyucu |
| 4. Ayarlanabilir Anahtar | 9. Geçme Anahtar – 7mm |
| 5. Seviye- 91,5 cm. | |

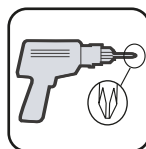

1

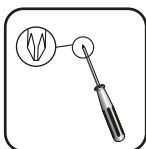

2

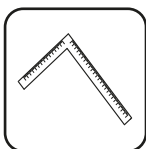

3



4

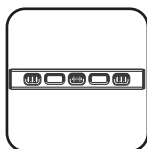

5



6



7



8

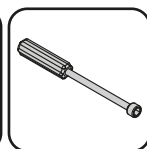

9

EN Parts List	CS Seznam součástí	IT Lista delle varie parti
FR Liste des pièces	SK Zoznam častí	PL Lista części
DE Teilleiste	SL Seznam delov	RO Lista elementelor componente
ES Listado de piezas	HR Dijelovi Lists	BG Списък на частите
PT Lista de Peças	HU Alkatrésztlista	TR Parça Listesi
NL Onderdelenlijst	SV Komponentlista	

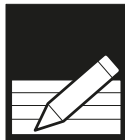
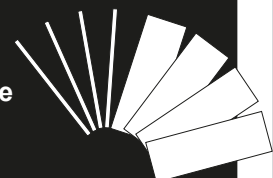

- EN** 1. Check all parts prior to installation.
2. Use screws with plastic washers on top of prepainted surface only.
3. Before starting installation, please refer to Safety & Precautions.

- FR** 1. Vérifier toutes les pièces avant l'installation.
2. Utilisez des vis avec des rondelles en plastique sur le dessus de la surface pré peinte seulement.
3. Avant de commencer l'installation, référez-vous svp à Sécurité et Précautions.

- DE** 1. Prüfen Sie alle Teile vor der Montage.
2. Benutzen Sie bei lackierten Oberflächen nur Schrauben mit Plastikunterlegscheiben.
3. Lesen Sie vor dem Aufbau die Sicherheitsanweisungen.

- ES** 1. Verifique todo el despiece antes del montaje.
2. Use los tornillos con las arandelas plásticas sobre la superficie pre pintadas.
3. Antes de comenzar el montaje, consulte el apartado de seguridad y precauciones.

- PT** 1. Confirme todas as peças antes da instalação.
2. Utilize parafusos com anilhas plásticas em cima da superfície prepainted apenas.
3. Antes de iniciar a instalação, cheque item "Segurança e Cuidados".

- NL** 1. Controleer vooraf of alle onderdelen aanwezig zijn.
2. Gebruik schroeven met plasticen ring aan de bovenkant of voor gelakt ondergrond.
3. Voordat u begint met installeren, verwijzing naar veiligheid voorschriften.

- CS** 1. Než začnete s montáží, zkontrolujte všechny součásti.
2. Používejte šrouby z plastovým těsněním pouze na natřenou plochu.
3. Před montáží si prosím přečtěte Bezpečnost a bezpečnostní opatření.

- SK** 1. Skontrolujte všetky časti pred inštaláciou.
2. Použite skrutky s plastovými podložkami len na natretej ploche.
3. Skôr ako začnete s inštaláciou, prečítajte si Bezpečnosť a bezpečnostné opatrenia.

- SL** 1. Pred montažo preverite vse dele.
2. Uporabite vijake s plastičnimi podložkami samo na vrhu grundirane površine.
3. Pred začetkom namestitve, glejte VARNOST & VARNOSTNI UKREPI.

- HR** 1. Provjera svih dijelova prije instalacije.
2. Koristite vijaka sa plastičnim podmetakima na vrhu od unaprijed obojana površinska.
3. Prije nego Vi počete instalacija, molim vas pogledajte Sigurnost i mjere opreza

- HU** 1. Ellenőrizzen minden alkatrészt az összeszerelés megkezdése előtt.
2. Előre festett felületeken csak műanyag alátétekkel használja a csavarokat.
3. Az összeszerelés megkezdése előtt kérjük vegye figyelembe a biztonsági utasításokat.

- SV** 1. Kolla alla delar före installationen.
2. Använd skruvar med plastbrickor bara på målade ytor.
3. innan man startar installationen ska man läsa igenom säkerhet & försiktighetsåtgärder.

- IT** 1. Controlla tutte le parti prima dell'installazione.
2. Usa viti con rondelle di plastica sulla parte superiore delle superfici preverniciate.
3. Prima di incominciare con l'installazione, per favore leggi attentamente i punti illustrati nel paragrafo Sicurezza ed Installazione.











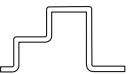

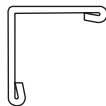



- PL** 1. Sprawdź wszystkie części zanim przystąpisz do montażu.
2. Używaj śrub z plastikowymi uszczelkami wyłącznie na wcześniej pomalowanej powierzchni.
3. Przed rozpoczęciem instalacji należy przeczytać rozdział Bezpieczeństwo i środki ostrożności.







- RO** 1. Verificați toate părțile componente înainte de instalare.
2. Folosiți șuruburi cu șaibe de plastic doar pe suprafața prevopsită.
3. Înainte de a începe asamblarea, consultați capitolul. Măsuri de siguranță și protecție.



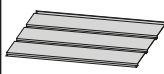
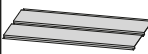
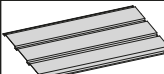



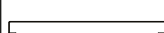

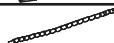

- BG** 1. Проверете всички части преди монтажа.
2. Използвайте винтове с пластмасови шайби само върху предварително боядисани повърхности.
3. Преди започване на монтажа, моля разгледайте Безопасност и Защита.

- TR** 1. Kurulumdan önce tüm parçaları kontrol ediniz.
2. Önceden boyanmış yüzey için sadece Vida ve plastik pul kullanınız.
3. Montaja başlamadan önce lütfen Güvenlik ve Önlemler kısmına bakınız.



	MP01	2
	MP02	2
	MA07	4
	ASLV	1
	ASRV	1
	AFV	2
	DHBT	4
	MP03	1
	MP04	2
	MP05	1
	MP06	4
	MP11	1
	MP12	1
	MP13	1
	MP14	1
	MP20	1
	CSLV	1
	CSRV	1
	CSTV	2
	CDFV	4
	TDFV	3
	DLFV	1
	HSPV	3

	MP07	2
	MP08	2
	MP09	2
	MP10	2
	MP15	1
	MP16	1
	MP17	1
	MP18	1
	MP19	1

	C01V	2
	CHV	3
	TC	4
	TB	3
	DLT	1
	DHT	7
	PW	1.5Slab
	PC	3Slab
	F1	16
	S1	179
	S2	78
	S8	16
	S3	9
	S17	6



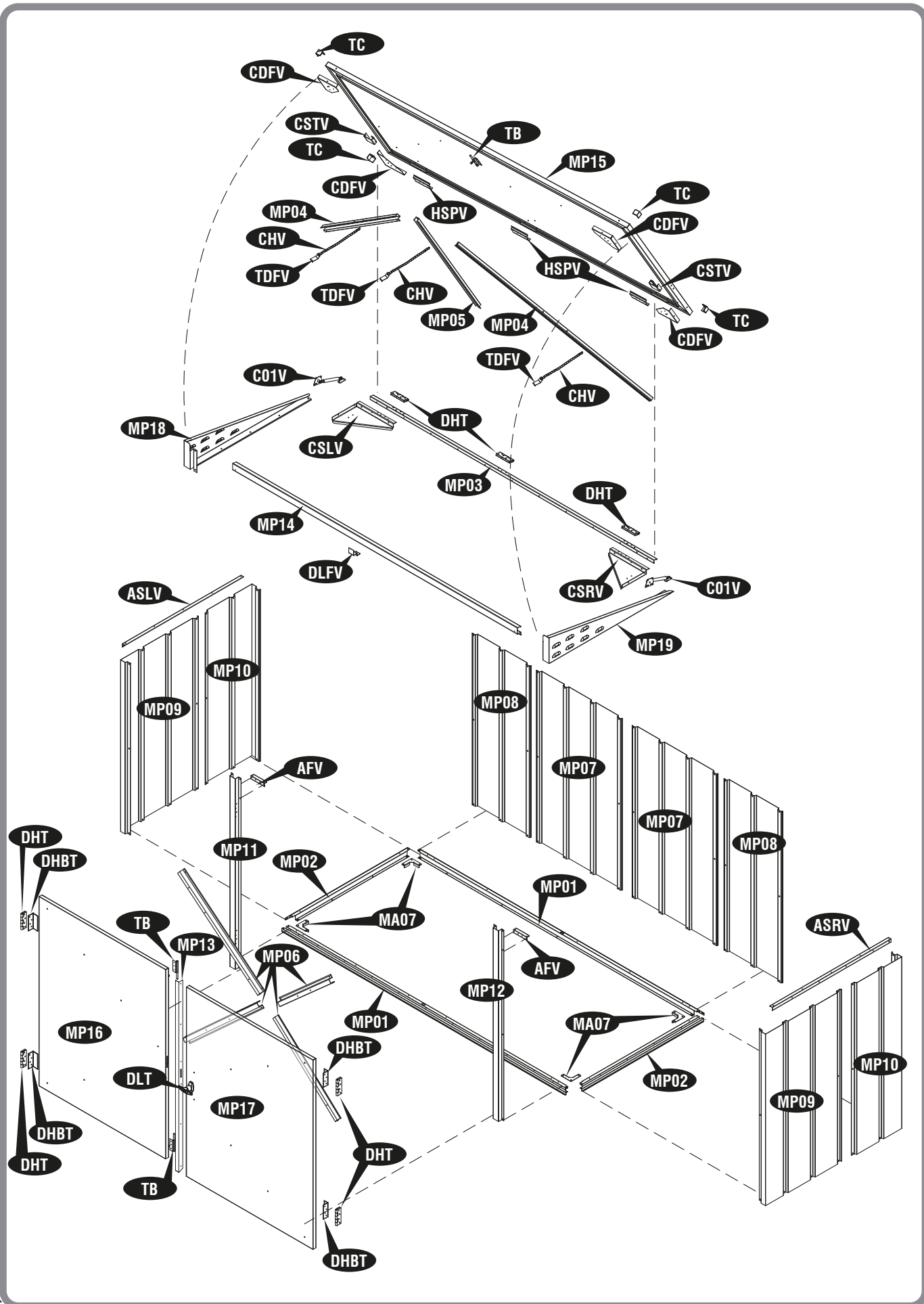

- 1** → # 16
- 2** → # 19-27
- 3** → # 28-34
- 4** → # 35-40

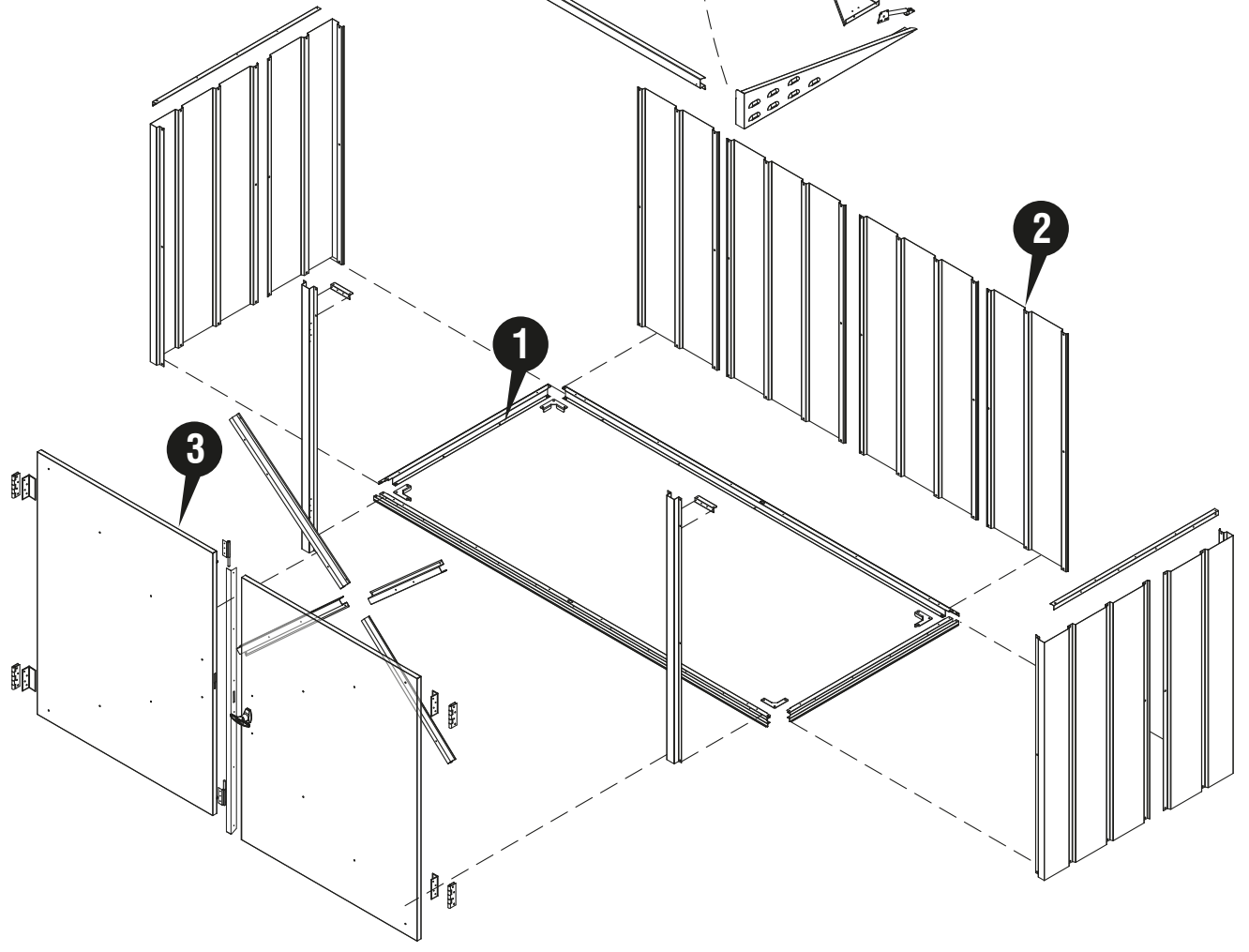
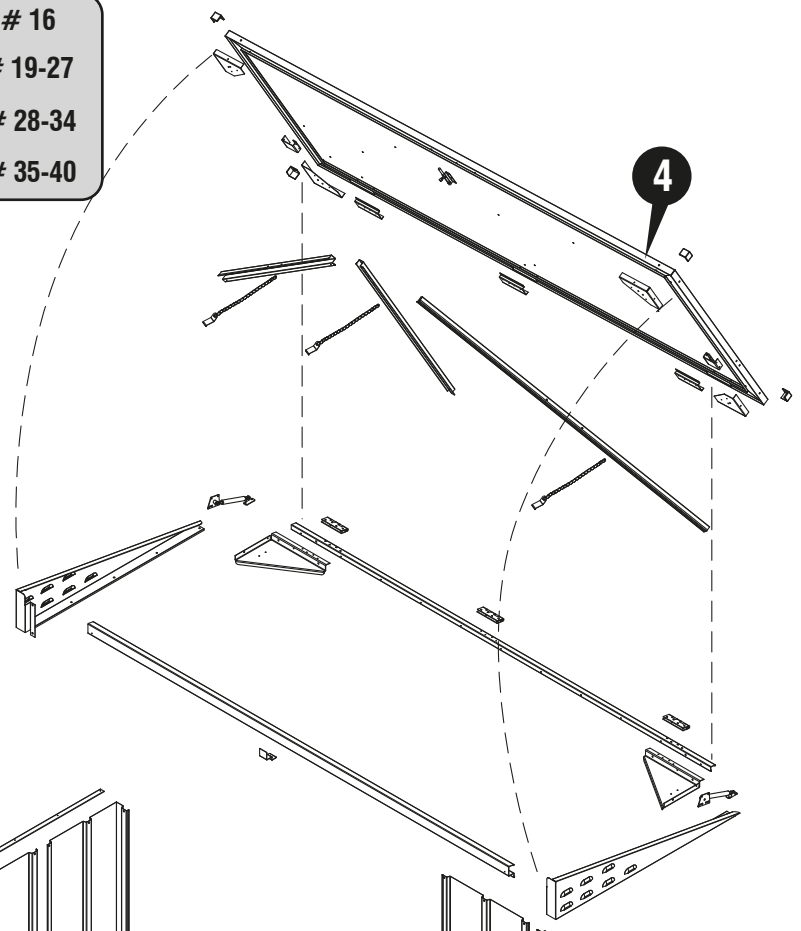



EN Foundation	CS Základy	IT Fondamenta
FR Fondation	SK Základ	PL Podstawa
DE Fundament	SL Temelj	RO Fundația
ES La cimentación	HR Temelj	BG Фундамент
PT Fundação	HU Alap	TR Temel
NL Fundering	SV Grunden	

EN DuraMax must be installed on a level wooden platform or a level concrete foundation.

FR DuraMax doit être installé sur une plate-forme en bois ou une fondation de béton..

DE DuraMax ist auf einer ebenen Holzplattform oder einem ebenen Betonfundament zu installieren.

ES La caseta debe montarse sobre una superficie plana de madera o una solera de hormigón.

PT Duramax deve ser instalado em uma plataforma de madeira o numa fundação de betão nivelada.

NL Een DuraMax schuur moet worden geïnstalleerd op een vlak houten platform of op een vlakke betonnen fundering.

CS DuraMax musí být instalován na rovnou dřevěnou plošinu nebo na rovný betonový základ.

SK DuraMax sa musí inštalovať na vodorovnú drevenú plošinu alebo na vyrovnaný betónový základ.

SL DuraMax je treba namestiti na ravno leseno ploščad ali ravno betonsko podlago.

HR DuraMax se mora instalirati na ravnu drvenu platformu ili na ravni betonski temelj.

HU A Duramax-ot Duramax alapra, szintetikus fapadlóra vagy szintetikus betonra kell telepíteni.

SV Duramax ska installeras på en jämn träplattform eller en jämn betonggrund.

IT DuraMax deve essere installato al livello della piattaforma di legno o a livello delle fondamenta in cemento.

PL DuraMax powinien być zainstalowany na poziomej platformie drewnianej lub na poziomej ławie fundamentowej.

RO DuraMax trebuie instalat pe o platformă de lemn nivelată sau pe o fundație de beton nivelată.

BG DuraMax трябва да се монтира на равна дървена платформа или равна бетонна основа.

TR DuraMax, düz bir ahşap platform veya düz bir beton temel üzerine kurulmalıdır.

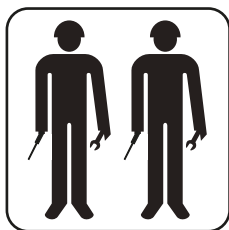

EN Two people needed.

FR Deux personnes nécessaires.

DE Zwei Leute brauchen.

ES Dos personas que se necesitan.

PT Duas pessoas precisavam.

NL Er waren twee mensen nodig.

CS Potřebovali dva lidi.

SK Dvaja ľudia potrebovali.

SL Potrebovali sta dve osebi.

HR Trebale su dvije osobe.

HU Két embernek volt szüksége.

SV Två personer behövde.

IT Sono necessarie due persone.

PL Potrzebne były dwie osoby.

RO Două persoane au avut nevoie.

BG Нужни бяха двама души.

TR İki kişiye ihtiyaç vardı.

EN Wooden Platform (Not Included)

CS Dřevěný základ (není součástí)

IT Piattaforma di legno (non incluso)

FR Plate-forme en bois (non incluse)

SK Drevený podklad (Nedodáva sa)

PL Platforma drewniana (nie objęte)

DE Holzplattform (nicht im Lieferumfang)

SL Leseni pod (ni priložen)

RO Platformă de lemn (Nu este inclusă)

ES Plataforma de madera (no incluida)

HR Drveni platform (Nije Uključena)

BG Дървена платформа (Не е включена)

PT Plataforma de madeira (Não incluida)

HU Fa emelvény (Nem szerepel a csomagban)

TR Tahta Platform (Pakete dahil değildir)

NL Houten platform (niet inbegrepen)

SV Träplattform (inte inkluderad)



1

1

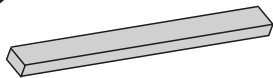

78 1/4" x 3 1/2" x 2" (x3)

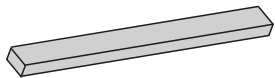

37 7/8" x 3 1/2" x 2" (x2)

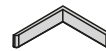

(x4)

(EN) Lay 2 x 4 Flat Pressure Treated Weather proof Wood Studs:
(Actual size 2" x 3 1/2", 50mm x 88.9mm)

(FR) Aire Plate 2" x 4" Pression de l'épreuve des intempéries
traités goujons de bois:
(Taille réelle 2" x 3 1/2", 50mm x 88.9mm)

(DE) 2x 4 wetterfeste, druckbehandelte Holzlatten auslegen:
(Aktuelle Größe 2" x 3 1/2", 50 x 88.9)

(ES) Coloque los listones perimetrales sobre los que echar la solera. Estos deben ser tratados para evitar que se expandan con el agua. Medidas de los mismo 50mm x 88,9mm

(PT) Deitare 2" x 4"mm Plano Pressão à prova de intempéries tratados parafusos prisioneiros de madeira:
(tamanho atual 2" x 3 1/2", 50mm x 88.9mm)

(NL) Laag 2 x 4 Vlak Druk behandeld weer bewijs hout hengsten
(Precieze maat 2 x 3 1/2, 50 mm x 88.9 mm)

(CS) Položte 2 x 4 plochy tlak ošetřené počasí proof dřevo hřeby.
(Skutečné velikosti 2" x 3 1/2", 50 x 88.9)

(SK) Plocha 2 x 4 tlak ošetřené počasie dôkaz drevené gombíky.
(Skutočné veľkosti 2" x 3 1/2", 50 x 88.9)

(SL) Položite ravno 2 x 4 pritisk obravnavajo vreme dokaz lesa klinov
(Dejanska velikost 2" x 3 1/2", 50 x 88.9)

(HR) Stavite 2 x 4 ravno Pressure Obradeni vremenski dokazni drveni klin.
(Stvarnoj veličini 2" x 3 1/2", 50 x 88.9)

(HU) 2 x 4 sima nyomás kezelt időjárás bizonyítékot szegekkel fa
(Tényleges méret 2" x 3 1/2", 50 x 88.9)

(SV) Lagg 2 x 4 platt Tryck behandlat väder bevis trä dubbar.
(Verklig storlek 2" x 3 1/2", 50mm x 88.9mm)

(IT) Laici 2 x 4 pressione trattati Meteo prova.
(Dimensione attuale 2" x 3 1/2", 50 mm x 88.9 mm)

(PL) Połóż płasko słupki 2x4 Ciśnienia traktowane pogodawód drewna stadniny
(Rzeczywisty rozmiar 2" x 3 1/2", 50mm x 88,9mm)

(RO) Așezați plăciile 2 x 4 pe o suprafață plană
Pressure tratate de intemperii Wood Studs
(Dimensiunea reală 2" x 3 1/2", 50 x 88.9)

(BG) Поставете плоскост с размери 2 x 4 Pressure Третирани Противотехнически дървесни щифтове.
(Застроена 2" x 3 1/2", 50 x 88.9)

(TR) 2 x 4 ölçüsünde zemin Pressure Tedavi Hava geçirmez Ahşap Studs.
(2" x 3 1/2", 50 x 88.9 Gerçek boyut)

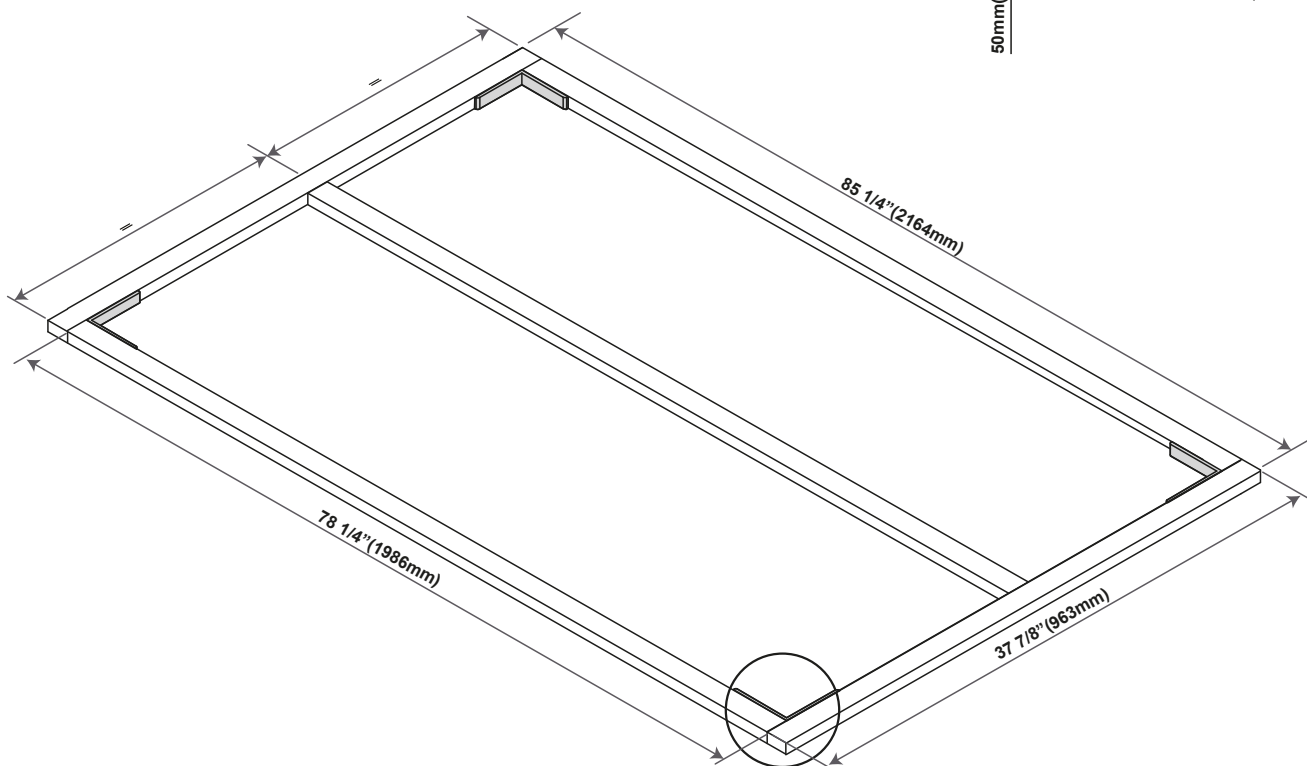
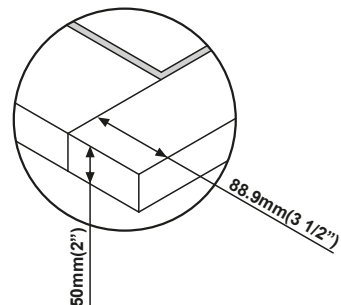

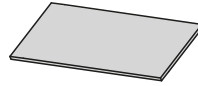

85¹/₄" x 37⁷/₈" X 3/4" (x1)



(EN) Exterior Grade (CDX) - 3/4" (19mm) Weather proof Marine grade plywood

(FR) Qualité extérieure (CDX) - 3/4 po (19mm) météo preuve Marine grade contreplaqué..

(DE) Aussenansicht Grade (CDX) - 3/4" (19mm) Wetter Beweis Marine Grade Sperrholz.

(ES) Calidad exterior (CDX) - 3/4" (19mm) de madera contrachapada y resistente al agua.

(PT) Grade exterior (CDX) - 3/4" (19mm) tempo prova da classe madeira compensada marinha.

(NL) Exterieur Grade (CDX) - 3/4" (19mm) weer bewijs Marine grade multiplex.

(CS) vnější Grade (CDX) - 3/4" (19mm) počasí důkaz Marine překližované desky.

(SK) exteriéru Grade (CDX) - 3/4" (19mm) počasie dôkaz Marine preglejku.

(SL) zunanjostr razred (CDX) - 3/4" (19mm) vreme dokaz Marine Les

(HR) Exterior Grade (CDX) - 3/4" (19mm) Mjerno vrijeme morska razreda šperploča..

(HU) külső fokozat (CDX) - 3/4" (19mm) Időjárás bizonyítékot tengeri minőségű rétegelt lemezt.

(SV) exteriör Grade (CDX) - 3/4" (19mm) väder bevis Marine grade plywood.

(IT) borchie di legno esterna Grade (CDX) - 3/4" (19mm) compensato Meteo prova Marine

(PL) Zewnętrzny stopień (CDX) - 3/4" (19mm) pogoda dowód Marine sklejkę :

(RO) Exterior Grad (CDX) - 3/4" (19mm) Rezistență la intemperii placaj de calitate marină.

(BG) Exterior Grade (CDX) - 3/4" (19mm) Противотемпературен шперплат.

(TR) Exterior Grade (CDX) - 3/4" (19mm) Hava geçirmez Deniz sınıfı kontrplak

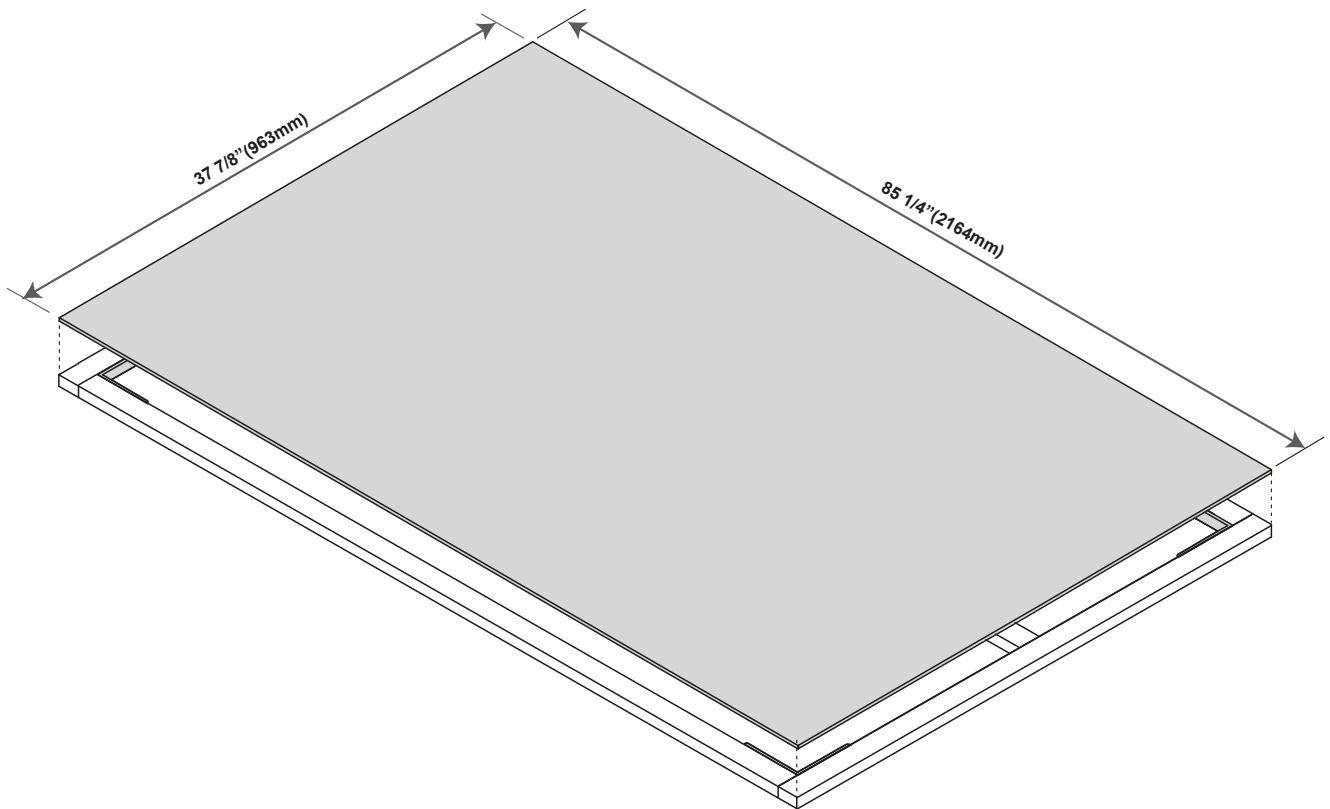

2

EN Concrete Platform

FR Plate-forme en béton armé

DE Betonaufgabe plattform

ES Base de hormigón

PT Plataforma concreta

NL Betonnen plaat

CS Betonové Platforma

SK Betónové Platforma

SL Betonski Platform

HR Betonski Platform

HU Beton Platform

SV Betongplattform

IT Piattaforma in cemento

PL Platforma betonowa

RO Platforma de beton

BG Бетон Платформа

TR Beton Platform



- EN** To ensure that your shed withstands high winds, we recommended to use this floor option. A concrete pad or a large size concrete patio stone squares is recommended for suitable floor base. Make sure it is firm and level and will allow drainage away from the site. Make a level concrete foundation, that has an outside dimension of 86 1/4" x 39" (2192mm x 991mm). For a concrete pad base, prepare a level bed for a firm footing layer of crushed stone. The concrete pad should then be poured to a thickness of 4 inches (100mm) to 5 inches (125mm). Allow to dry thoroughly for at least 48 hours. Manufacturer is not responsible for the choice and construction of the foundation.
- FR** Pour vous assurer que votre hangar résiste à des vents violents, nous avons recommandé d'utiliser cette option de plancher. Une dalle de béton ou une grande taille concrètes dalles de patio de est recommandé pour base appropriée au sol. Assurez-vous qu'il est ferme et niveau et permettre un bon drainage du site. Faire niveau fondation en béton, qui a une dimension extérieure de 86 1/4" x 39" (2192mm x 991mm). Pour hangar de base. Pour une dalle en béton, préparer une couche de graviers de nive au. La dalle doit faire entre 10 et 12.5 cm. Le tampon de béton doit ensuite être coulé sur une épaisseur de 4 pouces (100 mm) à 5 pouces (125 mm). Laisser sécher complètement pendant au moins 48 heures. Le fabricant n'est pas responsable du choix et de la construction des fondations.
- DE** Dieser Geräteschuppen sollte auf einem festen Untergrund (wie zum Beispiel einer Betonfläche oder Waschbetonplatten) aufgebaut werden. Stellen Sie sicher, dass eine Entwässerung der Aufstellfläche gewährleistet ist. Erstellen sie ein ebenes Betonfundament, mit den Außenmaßen 86 1/4" x 39" (2192mm x 991mm). Füllen Sie eine Kiesschicht ein und verdichten Sie diese (ggf. mit einer Rüttelplatte). Giesen Sie den Beton gleichmäßig ein, die Dicke sollte 100mm bis 125mm betragen. Anschließend mindestens 48 Stunden trocknen lassen. Der Hersteller ist nicht für die Auswahl des Fundaments verantwortlich.
- ES** Para asegurarse que su caseta resiste vientos fuertes le recomendamos usar esta opción de suelo. Tener una buena base de hormigón le dará más fuerza a la caseta. Asegúrese de colocar en un terreno perfectamente nivelado y que permita un correcto drenaje. Haga una base con un perímetro exterior con las siguientes medidas: 86 1/4" x 39" (2192mm x 991mm). Cree el perímetro y coloque piedra para hormigonar en su interior, y eche el hormigón hasta una altura de entre 100mm y 125mm. Déjelo secar al menos 48 horas. El fabricante no es responsable de la construcción de la base de hormigón.
- PT** Para garantir que o seu galpão resiste a ventos fortes, recomendamos usar esta opção de andar. Um bloco de concreto ou um quadrados de pedra de pátio de concreto de tamanho grande é recomendado para base apropriado do assoalho. Certifique-se que é firme e nivelada e permitirá drenagem longe do local. Fazer base de uma fundação de concreto nível, que tem uma dimensão exterior de 86 1/4" x 39" (2192mm x 991mm). Em um bloco de concreto, preparar uma cama de nível para uma camada firme de brita. O base de concreto deve ser derramado em seguida a uma espessura de 4 polegadas (100mm), 5 polegadas (125mm). Deixe para secar completamente pelo menos 48 horas. Fabricante não é responsável pela escolha e construção da Fundação.
- NL** Om ervoor te zorgen dat uw schuur bestand is tegen hoge winden, raden wij u aan deze vloeroptie te gebruiken. Een concrete pad of een groot formaat concrete patio stenen pleinen wordt aanbevolen voor geschikt woord basis. Zorg ervoor dat het is stevig en niveau en drainage zal toestaan weg van de site. Een niveau concrete stichting, die een externe dimensie van 86 1/4" x 39" (2192mm x 991mm). For a concrete pad base, prepare a level bed for a firm footing layer of crushed stone. The concrete pad should then be poured to a thickness of 4 inches (100mm) to 5 inches (125mm). Allow to dry thoroughly for at least 48 hours. Manufacturer is not responsible for the choice and construction of the foundation.
- CS** Aby ste zajistili, že váš haly odolává silnému větru, doporučujeme použít tuto podlahu. Pro vhodnou podlahovou základnu se doporučuje betonová podložka nebo velké betonové terasové čtverce. Ujistěte se, že je pevný a rovný a umožní odvodnění od místa. Vytvořte hladký betonový podklad, který má vnější rozměr 86 1/4" x 39" (2192mm x 991mm). pro základní shed. U betonové podložky připravte rovnou lůžko pro pevnou podkladovou vrstvu drčeného kamene. Betonová vložka by měla být nalita do tloušťky od 100 palců do 5 palců (125 milimetrů). Nechte důkladně vyschnout po dobu nejméně 48 hodin. Výrobce nezodpovídá za volbu a výstavbu nadace.
- SK** Aby ste zabezpečili, že vaša haly odolá vysokému vetru, odporúčame použiť túto podlahovú možnosť. Na vhodnú podlahovú základňu sa odporúča betónová podložka alebo veľké betónové terasové kamenné štvorce. Uistite sa, že je pevný a rovný a umožní odvodnenie z miesta. Vytvorte základový betónový základ, ktorý má vonkajší rozmer 86 1/4" x 39" (2192mm x 991mm). pre základňu. Pre betónové podložky pripravte hladkú vrstvu pre pevnú základovú vrstvu drveného kameňa. Betónová podložka by mala byť potom naliata do hrúbky 4 palce (100 mm) až 5 palcov (125 mm). Nechajte dôkladne vysušiť aspoň 48 hodín. Výrobca nie je zodpovedný za výber a výstavbu nadácie.
- SL** Da bi zagotovili, da bo vaša hiša odtegnila visoke vetrove, smo priporočili, da uporabite to možnost. Za primerne talne podlage je priporočljiva betonska podloga ali betonski trgi z velikimi površinami. Prepričajte se, da je čvrsta in raven ter omogočila drenažo stran od mesta. Izdelajte ravno betonsko podlago, ki ima zunanjo dimenzijo dimenzij 86 1/4" x 39" (2192mm x 991mm). za Basic Shed. Za betonsko podlago pripravite ravno posteljo za trdno podlago iz drobljenega kamna. Betonsko ploščo je treba nato vliti do debeline 4 palcev (100 mm) do 5 palcev (125 mm). Pustite, da se temeljito posuši najmanj 48 ur. Proizvajalec ni odgovoren za izbiro in gradnjo temeljev.
- HR** Da bismo osigurali da vaš prolaz izdrži jak vjetar, preporučujemo da upotrijebite tu podu. Za pogodnu podnu bazu preporučuje se betonska podloga ili velike kamene ploče od betona. Pobrinite se da je čvrsta i razina i omogućiti će odvod daleko od stranice. Izradite temeljni betonski temelj koji ima vanjsku dimenziju od 86 1/4" x 39" (2192mm x 991mm). za Basic Shed. Za betonsku podlogu, pripremite krevet na razini za čvrsto podnožje slomljenog kamena. Betonsku podlogu treba zatim izliti na debljinu od 100 mm do 125 inča. Ostavite temeljito suhom najmanje 48 sati. Proizvođač nije odgovoran za odabir i izgradnju zaklade.



HU Annak érdekében, hogy a fészker ellenálljon a magas szeleknek, javasoljuk, hogy használja ezt a padlót. Betonpárna vagy nagyméretű betonpadló kőpadok ajánlottak megfelelő padlóalapra. Győződjön meg arról, hogy szilárd és vízszintes, és lehetővé teszi a vízvezetést távol a helyszíntől. Végezzünk el egy szintetikus alapot, amely 86 1/4" x 39" (2192mm x 991mm). külső méretekkel rendelkezik a Basic Shed számára.
Betonpárnás aljzat esetén készítsen egy szintes ágyat egy szilárd alapozórétre. A betonpárnát ezután 100 mm-es és 125 mm-es vastagságúra kell önteni. Legalább 48 órán keresztül hagyja alaposan száradni. A gyártó nem vállal felelősséget az alapítvány kiválasztásához és megépítéséért.

SV För att säkerställa att din skjul tål hög vind rekommenderar vi att du använder det här golvalternativet. En betongkudde eller en stor betongplattform stenplattor rekommenderas för lämplig golvyta. Se till att den är fast och jämn och gör det möjligt att dränera bort från platsen. Gör en jämn betongfundament, som har en yttre dimension av 86 1/4" x 39" (2192mm x 991mm). för Basic Shed.
För en betongplatta bas, förbereda en nivå säng för ett fast fotskikt av krossad sten. Betongplattan ska sedan hållas till en tjocklek av 4 tum (100 mm) till 5 tum (125 mm). Låt torka noggrant i minst 48 timmar. Tillverkaren ansvarar inte för valet och bygandet av stiftelsen.

IT Per garantire che il tuo capannone sopporta venti elevati, abbiamo consigliato di utilizzare questa opzione a pavimento. Si consiglia un tappetino in calcestruzzo o un quadrato in pietra di cemento in grande formato per una base adatta. Assicurarsi che sia stabile e livellato e permetterebbe di drenare lontano dal sito. Realizzare una base di calcestruzzo di livello, che ha una dimensione esterna di 86 1/4" x 39" (2192mm x 991mm). per Basic Shed.
Per una base di rilievo in calcestruzzo, preparare un letto a livello per un solido strato di pietra schiacciata. Il tappetino di calcestruzzo deve quindi essere versato ad uno spessore da 100 mm a 125 centimetri. Lasciare asciugare accuratamente per almeno 48 ore. Il produttore non è responsabile della scelta e della costruzione della fondazione.

PL Aby mieć pewność, że Twoja szopa wytrzyma silne wiatry, zalecamy skorzystanie z tej opcji podłogi. Jako odpowiednią podstawę podłogową zaleca się betonową podkładkę lub duże betonowe kwadraty tarasowe. Upewnij się, że fundament jest twardy i równy oraz umożliwia drenaż z dala od miejsca pracy. Wykonaj równy fundament betonowy o wymiarach zewnętrznych 86 1/4" x 39" (2192mm x 991mm) mm dla podstawowej szopy.
W przypadku podkładki betonowej należy przygotować równe podłoże na mocną warstwę podłoża z tłucznią kamiennego. Betonową podkładkę należy następnie wylać do grubości od 100 mm do 125 mm. Pozostawić do całkowitego wyschnięcia na co najmniej 48 godzin. Producent nie ponosi odpowiedzialności za wybór i budowę fundamentu.

RO Pentru a vă asigura că vaporul dvs. rezistă unor vânturi puternice, am recomandat să folosiți această opțiune pentru podea. Un tampon de beton sau o pătrată de piatră din beton de dimensiuni mari este recomandată pentru o bază adecvată pentru podea. Asigurați-vă că este ferm și la nivel și va permite scurgerea departe de site. Asigurați o fundație de beton de nivel, care are o dimensiune exterioară de 86 1/4" x 39" (2192mm x 991mm). pentru Shed Basic.
Pentru o bază de bază de beton, pregătiți un pat de nivel pentru un strat ferm de piatră zdrobită. Plăcuța de beton trebuie apoi turnată la o grosime de 4 inci (100 mm) până la 5 inci (125 mm). Lăsați-l să se usuce bine timp de cel puțin 48 de ore. Producătorul nu este responsabil pentru alegerea și construirea fundației.

BG За да сте сигурни, че Вашата барака издържа високи ветрове, препоръчваме да използвате тази опция за пода. За подходяща подова основа се препоръчва използването на бетонна подложка или големи бетонни квадратни плочки. Уверете се, че тя е здрава и равна и ще позволи дренаж далеч от мястото. Направете нивелирана бетонна основа, която има външен размер от 86 1/4" x 39" (2192mm x 991mm). за основен навес.
За бетон основа на подложка, подгответе ниво легло за твърда основа слой от натрошен камък. След това бетонната подложка трябва да се излива на дебелина от 4 инча (100 mm) до 5 инча (125 mm). Оставете да изсъхне напълно за поне 48 часа. Производителят не носи отговорност за избора и изграждането на основата.

TR Sunduğunuzdan yüksek rüzgarlara dayanıklı olmasını sağlamak için bu zemin seçeneğini kullanmanızı öneririz. Uygun taban tabanı için beton bir yastık veya büyük boy bir beton bahçe avlusu karosu önerilir. Sert ve sağlam olduğundan ve drenajın yerinden uzaklaşmasına izin vereceğinden emin olun. Basic Shed için dış boyut 86 1/4" x 39" (2192mm x 991mm). olan düz bir beton temel oluşturun.
Beton pad taban için, ezilmiş taştan sağlam bir taban tabakası için düz bir yatak hazırlayın. Beton pedi daha sonra 4 inç (100mm) ile 5 inç (125mm) arasındaki bir kalınlığa dökülmelidir. En az 48 saat boyunca iyice kurumasına izin verin. Üretici, vakfın seçimi ve yapımı için sorumlu değildir.

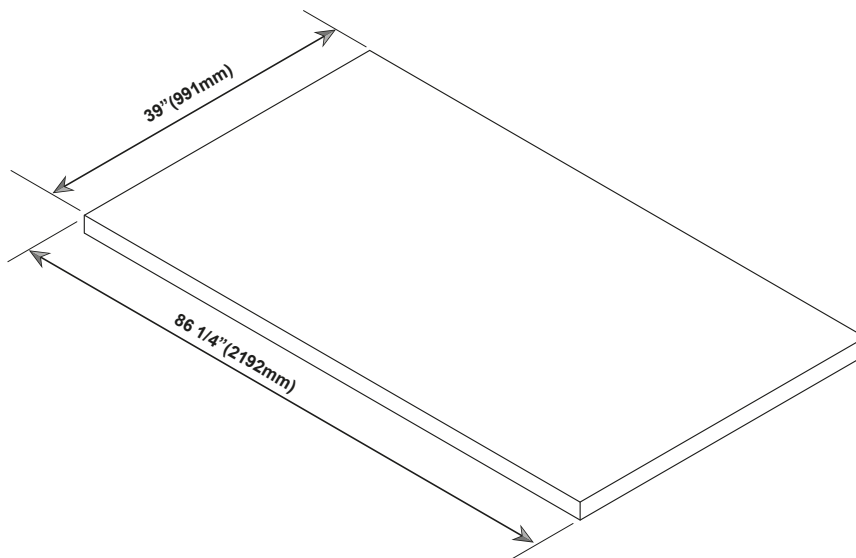

- EN** 1. Set the Torque limit of your Screw drill to #3 or #4 to ensure the Screws do not strip the Metal reinforcements.
2. It is important that these instructions are followed step by step.
3. Don't install under windy conditions.
4. All panels are clearly marked and care should be taken to use the correct one.
5. Use screws with plastic washers on top of prepainted surface only.
- FR** 1. Réglez la limite de couple de votre perceuse Vis à n # 3 ou n # 4 pour s'assurer que les vis ne supprime pas les renforts métalliques
2. Il est important que ces instructions soient suivies pas à pas.
3. Ne pas installer sous conditions de vent.
4. Toutes les parois sont clairement identifiées et il faut veiller à utiliser la bonne.
5. Utilisez des vis avec des rondelles en plastique sur le dessus de la surface pré peinte seulement.
- DE** 1. Stellen Sie das Drehmoment Ihres Akkschraubers auf Stufe 3 oder 4. Dies verhindert ein Überdrehen der Schrauben.
2. Diese Anleitung muss unbedingt Schritt für Schritt befolgt werden.
3. Die Montage nicht bei windigem Wetter vornehmen.
4. Alle Platten sind deutlich gekennzeichnet, und es sind unbedingt jeweils die richtigen Platte zu verwenden.
5. Benutzen Sie bei lackierten Oberflächen nur Schrauben mit Plastikunterlegscheiben.
- ES** 1. Establecer el límite de par de su taladro tornillo de # 3 y # 4 para asegurar los tornillos no tira los refuerzos metálicos.
2. es importante que estas instrucciones se sigan paso a paso.
3. No instale en días de mucho viento.
4. Todos los paneles están claramente señalizados y asegúrese de seleccionar el correcto en cada momento del montaje.
5. Use los tornillos y las arandelas plásticas solo en las partes pre pintadas.
- PT** 1. Defina o limite de Torque de sua broca parafuso para # 3 ou # 4 para garantir que os parafusos não tira os reforços de metal.
2. É importante que estas instruções sejam seguidas passo a passo.
3. Não instale sob condições com forças ventanosas.
4. Todos os painéis estão claramente marcados, um cuidado deve ser tomado para o uso correcto.
5. Utilize parafusos com anilhas plásticas em cima da superfície prepainted apenas.
- NL** 1. Stel de Torque limiet van uw Schroef boormachine op # 3 en # 4 om de schroeven zorgen niet strip de Metal versterkingen.
2. Het is belangrijk dat volgende instructies stap voor stap worden gerespecteerd.
3. Nooit de schuur installeren onder winderige omstandigheden.
4. Markeer alle panelen zorgvuldig en gebruik altijd de juiste panelen.
5. Gebruik schroeven met plasticen ring aan de bovenkant of voor gelakt ondergrond.
- CS** 1. Nastavte mezní hodnotu točivého momentu vrtáku na #3 nebo #4, abyste zajistili, že šrouby neztáhnou kovové výztuhy.
2. Je důležité aby jste tento návod sledovali krok za krokem.
3. Nemontujte při větrném počasí.
4. Každý panel je označen a musíte dávat pozor zda používáte ten správný.
5. používejte šrouby z plastovým těsněním pouze na natřenou plochu.
- SK** 1. Nastavte limit krútiaceho momentu vrtacieho vrtáku na #3 alebo #4, aby ste zaistili, že skrutky nezaberajú kovové výztuhy.
2. Je nutné dodržiavať tieto inštrukcie krok za krokom.
3. Neinštalujte za veterných podmienok.
4. Všetky panely sú jasne označené a pozorne si treba vybrať ten správny.
5. Použite skrutky s plastovými podložkami len na natretej ploche.
- SL** 1. Za omejitev vrtilnega momenta vijaka nastavite #3 ali #4, da zagotovite, da vijaki ne ojačitijo kovinskih ojačitev.
2. Pomembno je, da sledite opisanim navodilom korak za korakom.
3. Montaže ne izvijajte, kadar piha močen veter.
4. Vse plošče so jasno označene. Paziti je treba, da vzamete vsakokrat pravilno ploščo.
5. Uporabite vijake s plastičnimi podložkami samo na vrhu grundirane površine.
- HR** 1. Postavite granicu zakretnog momenta Vašeg vijčanog bušilica na #3 ili #4 kako biste osigurali da vijci ne skidaju metalna pojačanja.
2. To je važno da ovih instrukcije su slijedili korak po korak.
3. Nemojte instalirati pod vjetrovitim uvjetima.
4. Svi paneli su jasno označene i brigu treba poduzeti kako bi se koristiti ispravan panel
5. Koristite vijaka sa plastičnim podmetakima na vrhu od unaprijed - obojana površinska.
- HU** 1. Állítsa a csavarhúzó nyomatékhatárait #3 vagy #4-re, hogy a csavarok ne csavarják le a fém vasalatokat
2. Fontos, hogy az itt következő instrukciókat lépésről lépésre betartsa.
3. Szeles időben ne végezzen összeszereléset.
4. Minden panel egyértelműen meg van jelölve, ügyeljen arra, hogy a megfelelőt használja.
5. Előre festett felületeken csak műanyag alátétekkel használja a csavarokat.
- SV** 1. Ställ in momentskraven på din skruvborr till #3 eller #4 för att säkerställa att skruvarna inte slår av metallförstärkningarna.
2. Det är viktigt att dessa instruktioner följs steg för steg.
3. Installera inte när det är blåsigt.
4. Alla paneler är tydligt markerade och försiktighet bör vidtas för att använda rätt.
5. Använd skruvarna med plastskivor endast på förmålad yta.
- IT** 1. Impostare il limite di coppia della fresa a vite a #3 o #4 per assicurare che le viti non striscia i rinforzi metallici
2. E' molto importante che queste istruzioni vengano seguite passo dopo passo.
3. Non installare in presenza di forte vento.
4. Tutti i pannelli sono chiaramente contrassegnati e bisogna fare attenzione a usare quello corretto.
5. Usare viti con rondelle di plastica solo sulla superficie pre-verniciata.
- PL** 1. Ustaw limit momentu obrotowego wiertła do śrub od #3 do #4, aby upewnić się, że śruby nie zdejmą metalowych wzmocnień.
2. Bardzo ważne jest, by dokładnie stosować się do niniejszej instrukcji.
3. Nie należy montować w przypadku silnego wiatru.
4. Wszystkie panele ściennie są dokładnie oznakowane i należy zwrócić uwagę, aby używać właściwych elementów.
5. Używaj śrub z plastikowymi uszczelkami wyłącznie na wcześniej pomalowanej powierzchni.
- RO** 1. Setati limita de cuplu a burghiului dvs. de șurub la #3 sau #4 pentru a vă asigura că șuruburile nu lărgește armăturile metalice.
2. Este importantă respectarea pas cu pas a acestor instrucțiuni.
3. Nu instalați dacă vântul atinge viteze mari.
4. Toate panourile sunt clar marcate și trebuie avut grijă să se folosească cel corect.
5. Folosiți șuruburi cu șaibe de plastic doar pe suprafața prevopsită.
- BG** 1. Нагласете границата на въртящия момент на винтовата витла до #3 или #4, за да се уверите, че винтовете не изрязват металните подсилвания.
2. Важно е да следвате инструкциите стъпка по стъпка.
3. Да не се монтира при ветровито време.
4. Всички панели са ясно маркирани и трябва да се внимава за правилното използване на всеки от тях.
5. Използвайте винтове с пластмасови шайби само върху предварително боядисани повърхности.
- TR** 1. Vidaların Metal takviyeleri soymadığından emin olmak için Vidalı matkabınızın Moment sınırını #3 veya #4'e ayarlayın.
2. Talimatların sırasıyla uygulanması önemlidir.
3. Rüzgarlı havalarda kurmayınız.
4. Bütün paneller dikkatlice işaretlenmeli ve doğru olanın kullanımına dikkat edilmelidir.
5. Önceden boyanmış yüzey için sadece Vida ve plastic pul kullanınız.





- 1**
- | | | |
|-----------------------|--------------------|----------------------|
| EN Base Frame | CS Základní kostra | IT Cornice di Base |
| FR Canaux de base | SK Základňový rám | PL Rama fundamentowa |
| DE Bodenrahmen | SL Osnovni okvir | RO Rama bazei |
| ES Armazón de la base | HR Baza okvir | BG Основна Рама |
| PT Base de armação | HU Alapváz | TR Temel Çerçevesi |
| NL Basis frame | SV Basram | |

- | | | |
|-----------------------|-----------------------------------|-----------------------------------|
| EN Parts needed | CS Potřebné součásti | IT Parti occorrenti |
| FR Pièces nécessaires | SK Potrebne časti | PL Niezbędne elementy |
| DE Benötigte Teile | SL Dele, ki jih boste potrebovali | RO Elementele componente necesare |
| ES Piezas necesitadas | HR Dijelovi potreban | BG Необходими части |
| PT Peças Necessárias | HU Szükséges részek | TR Gereklı parçalar |
| NL Onderdelen nodig | SV Delar som behövs | |

MP01	2
MP02	2
MA07	4
S1	16

F1	16
S2	16
S8	16



1

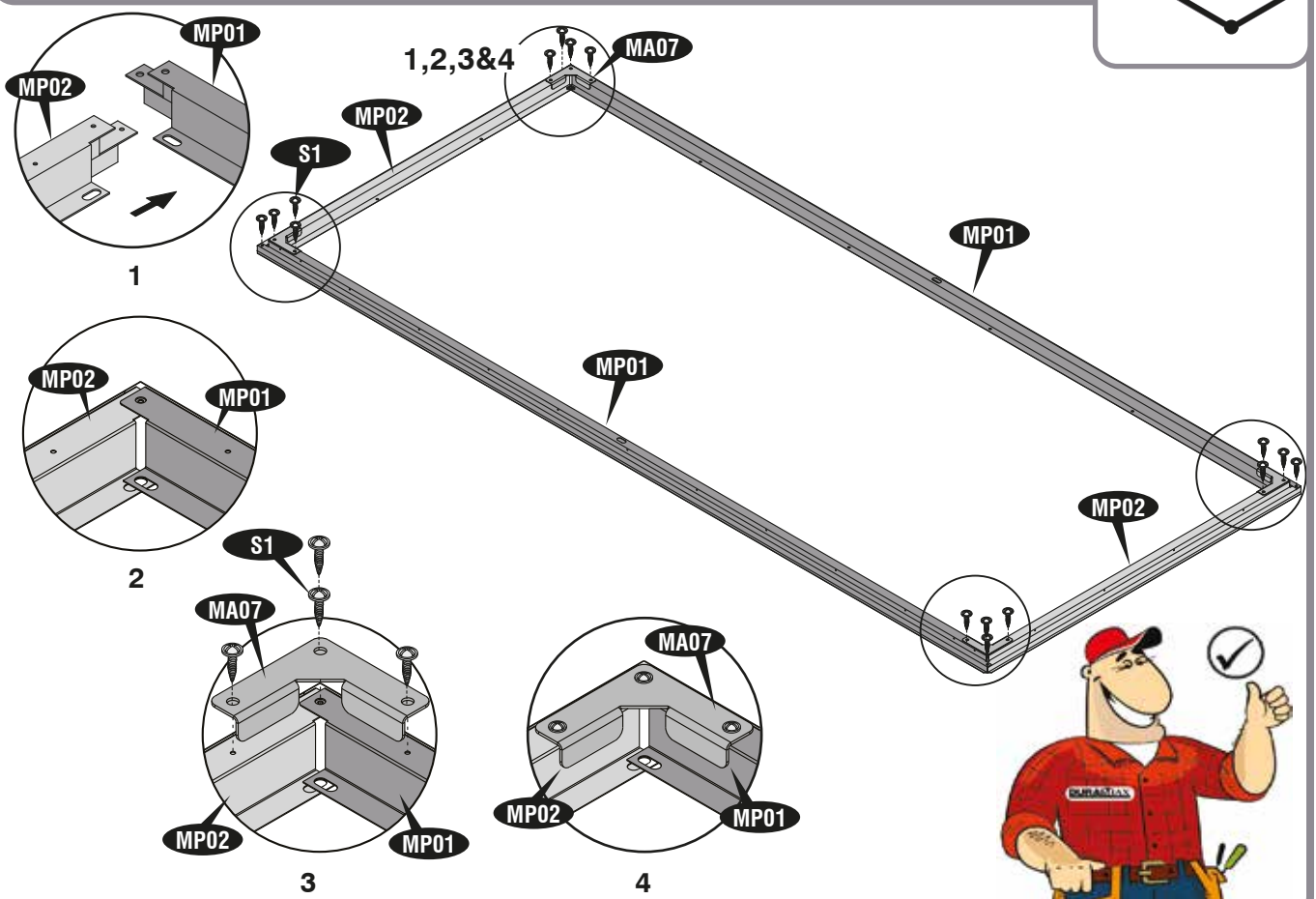

EN Assembly on Wooden platform

FR Ensemble sur plate-forme en bois

DE Montage auf Holzplattform

ES Montaje de la plataforma de madera

PT Montagem em plataforma de madeira

NL Montage op houten platform

CS Montáž na dřevěnou plošinu

SK Montáž na drevenej plošine

SL Montaža na leseni plošči

HR Montaža na drvenoj platformi

HU Összeszerelés faplatformon

SV Montering på träplattform

IT Montaggio su piattaforma in legno

PL Montaż na drewnianej platformie

RO Adunarea pe platforma de lemn

BG Сглобяване на дървена платформа

TR Ahşap platform üzerine montaj



2a

 S2 (x16)

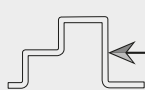

2036mm

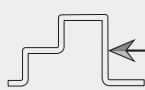
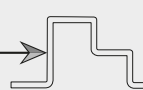

834mm

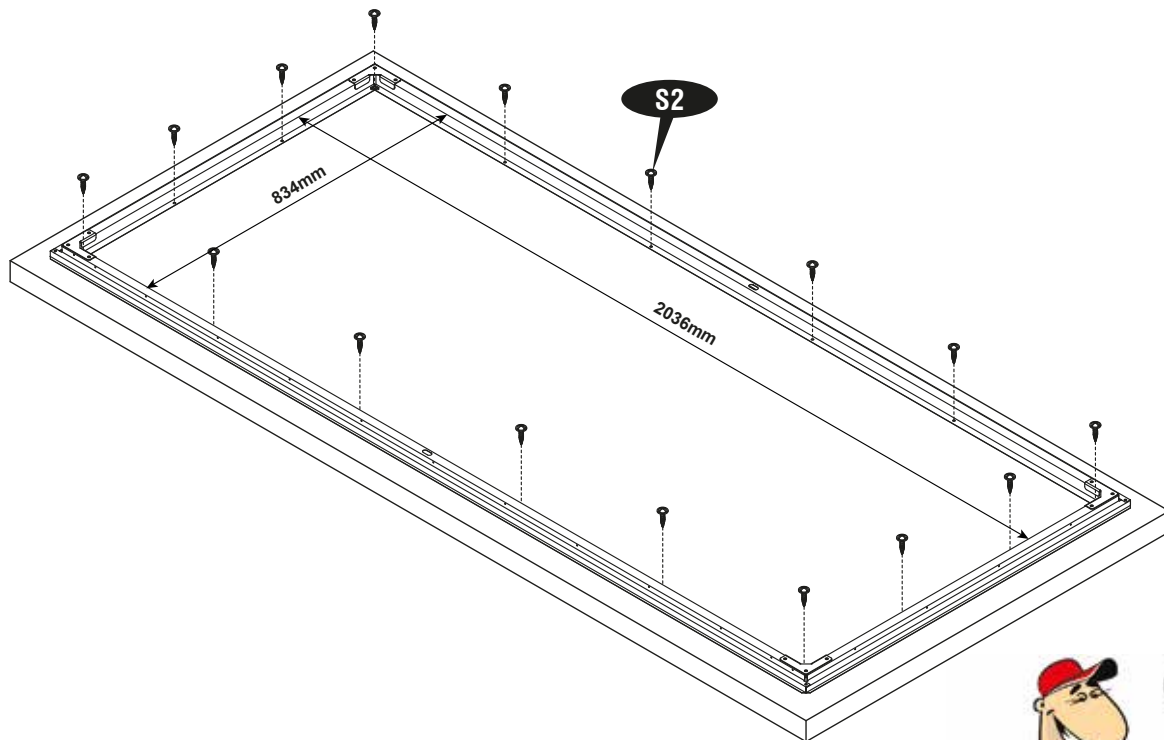
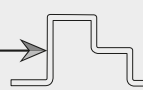

EN Assembly on Concrete Platform

CS Montáž na betonové plošině

IT Montaggio su piattaforma in calcestruzzo

FR Assemblage sur plate-forme en béton

SK Montáž na betónovú plošinu

PL Montaż na betonowej platformie

DE Montage auf Betonplattform

SL Montaža na betonsko ploščad

RO Adunarea pe platforma de beton

ES Montaje sobre la base de hormigón

HR Montaža na betonskoj platformi

BG Монтаж на бетонна платформа

PT Montagem em plataforma de concreto

HU Szerelés beton felületen

TR Beton platform üzerine montaj

NL Montage op betonplatform

SV Montering på betongplattform



2b

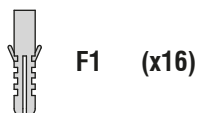

F1 (x16)



S8 (x16)

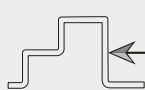

2036mm

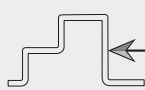
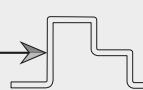

834mm

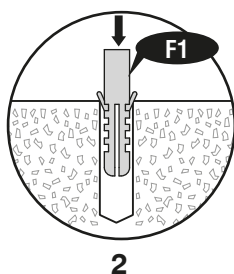
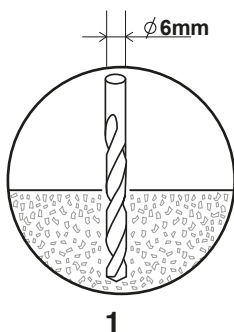
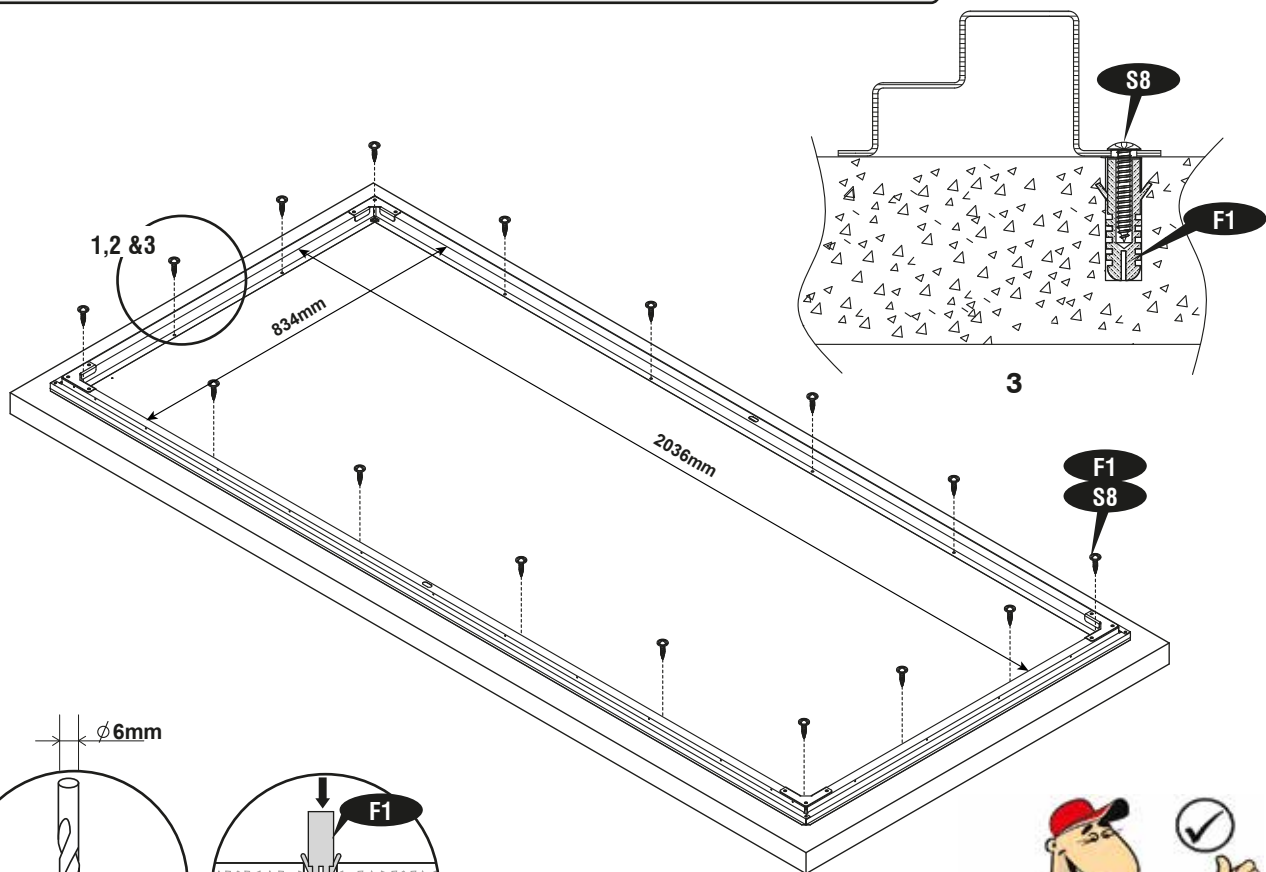
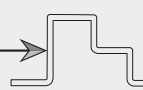

1

2





- 2**
- | | | |
|-----------------------|----------------------|------------------------|
| EN Walls & Columns | CS Zdi a kolumny | IT Pareti & Colonne |
| FR Murs et colonnes | SK Steny a stĺpy | PL Ściany i Kolumny |
| DE Wände und Säulen | SL Stene in stebri | RO Pereți și stâlpi |
| ES Columnas y paredes | HR Zidovi i Kolumne | BG Стени & Колони |
| PT Paredes e Colunas | HU Falak és oszlopok | TR Duvarlar & Sütunlar |
| NL Panelen en stijlen | SV Väggar & Kolumner | |

- | | | |
|-----------------------|-----------------------------------|-----------------------------------|
| EN Parts needed | CS Potřebné součásti | IT Parti occorrenti |
| FR Pièces nécessaires | SK Potřebné části | PL Niezbędne elementy |
| DE Benötigte Teile | SL Dele, ki jih boste potrebovali | RO Elementele componente necesare |
| ES Piezas necesarias | HR Dijelovi potreban | BG Необходими части |
| PT Peças Necessárias | HU Szükséges részek | TR Gerekli parçalar |
| NL Onderdelen nodig | SV Delar som behövs | |

AFV	2
ASLV	1
ASRV	1
CSLV	1
CSRV	1
DLFV	1
MP03	1
MP07	2

MP08	2
MP09	2
MP10	2
MP11	1
MP12	1
MP14	1
MP18	1
MP19	1

S1	59
S2	6
S3	9
PW	59

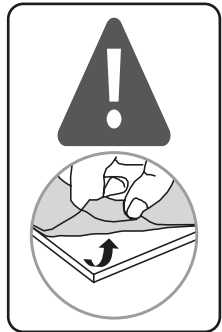

1

	MP09 (x1)		S1 (x2)		PW (x2)
---	-----------	---	---------	---	---------

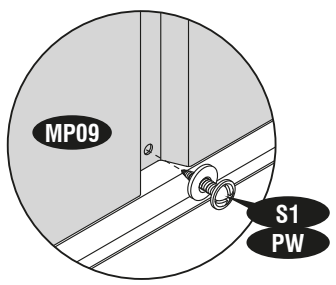

1

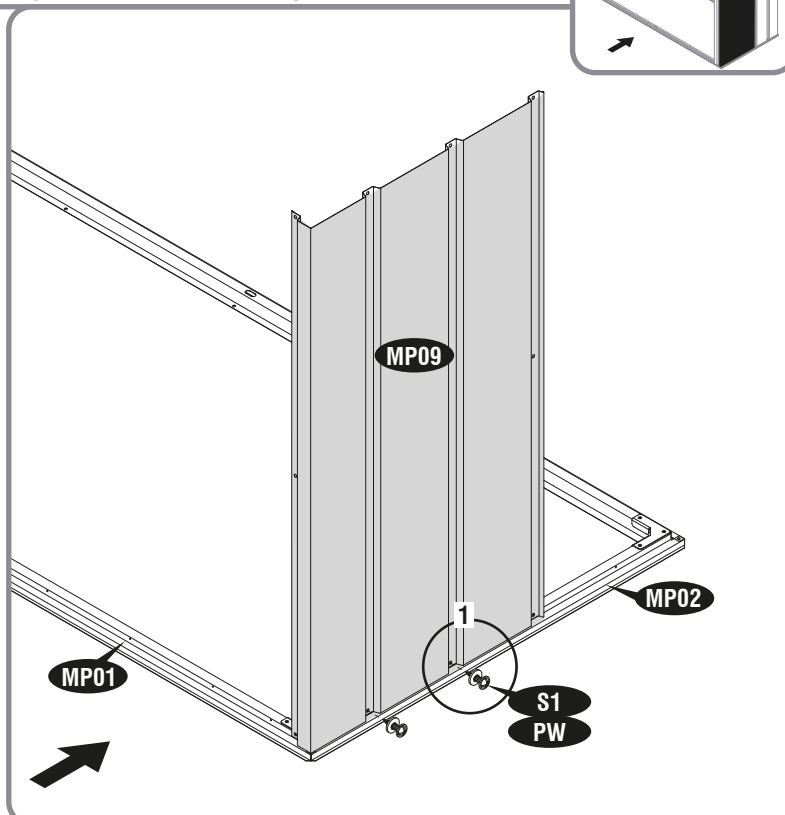

2

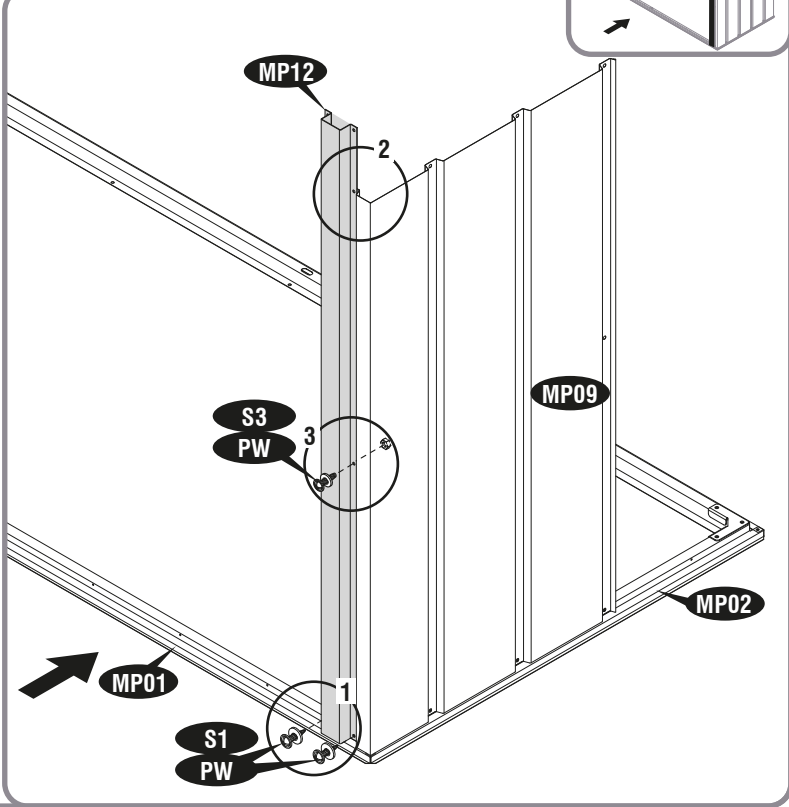
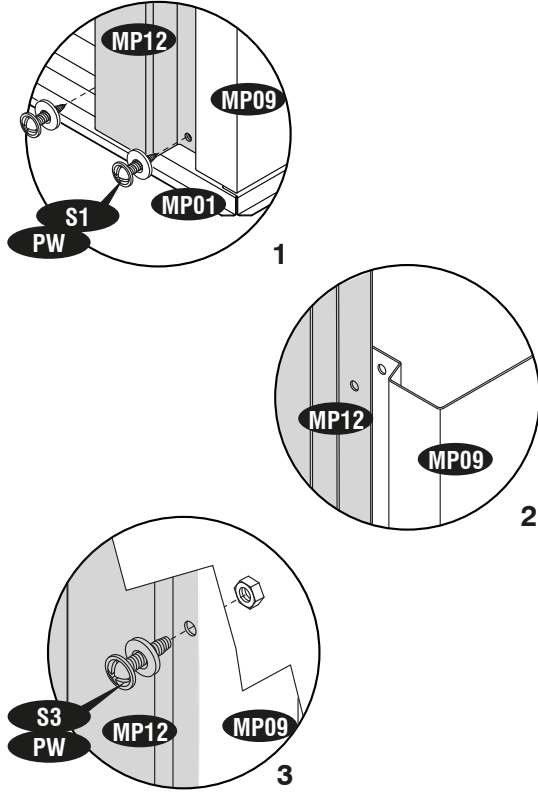
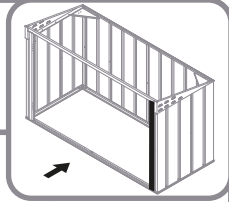
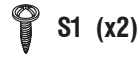
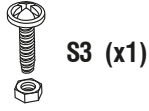
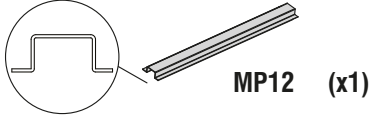

3

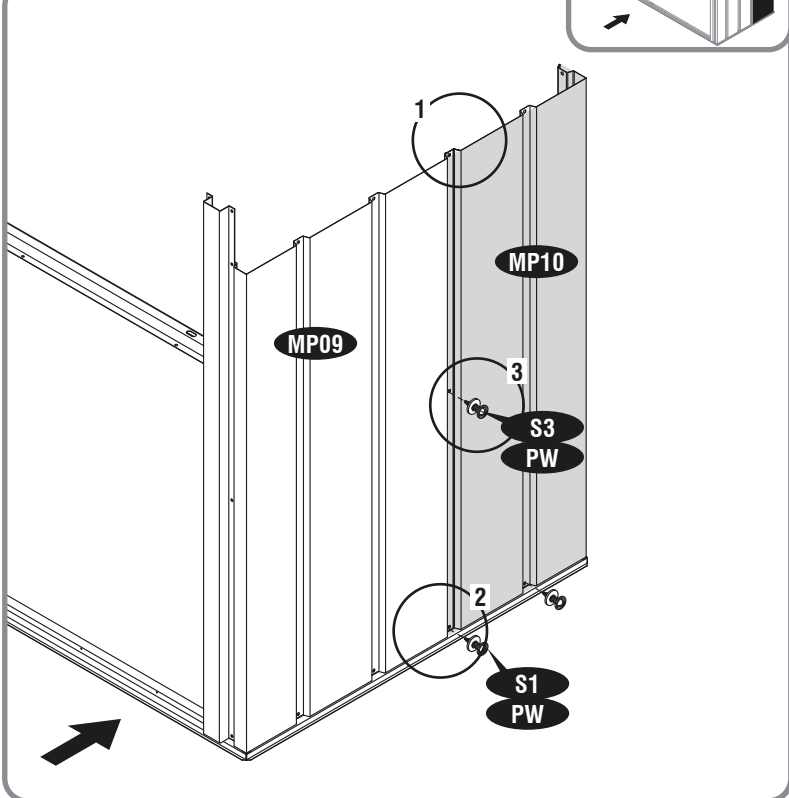
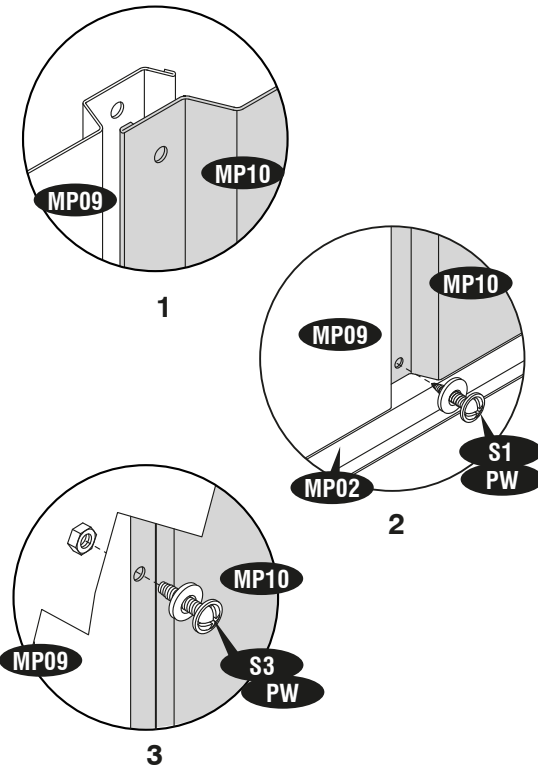
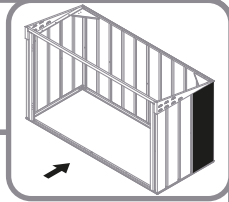
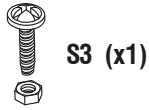
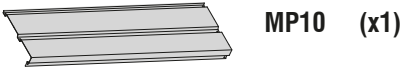

4

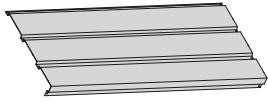

MP09 (x1)



S1 (x2)



PW (x2)

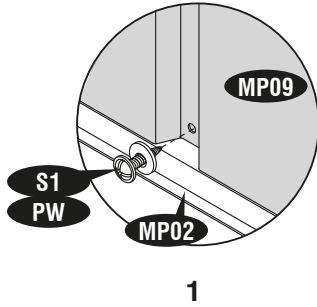
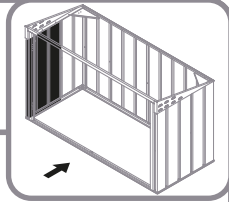

1

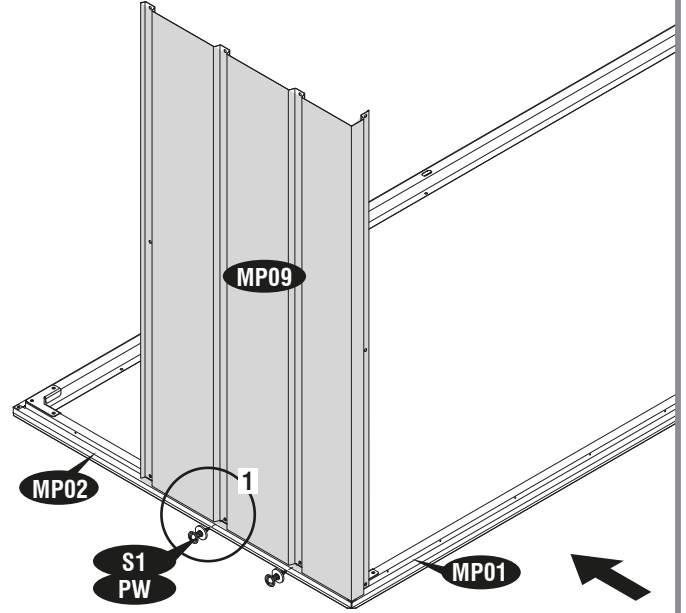

5

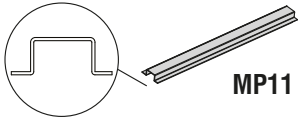

MP11 (x1)



S3 (x1)



S1 (x2)



PW (x3)

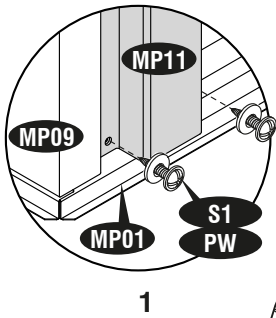
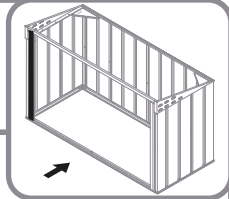

1

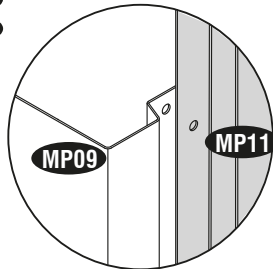

2

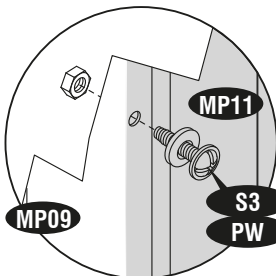

3

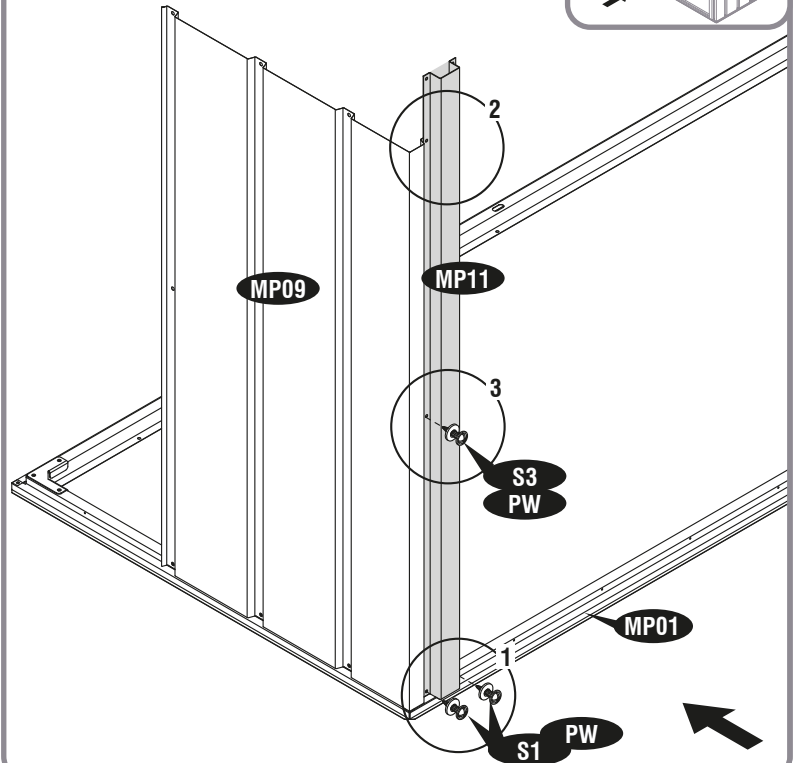

6

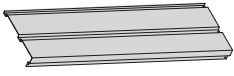

MP10 (x1)

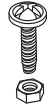

S3 (x1)



S1 (x2)



PW (x3)

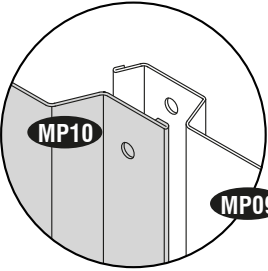
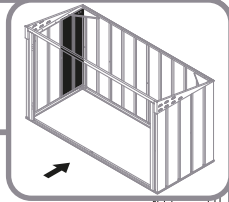

1

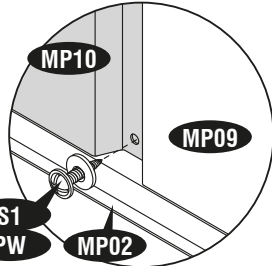

2

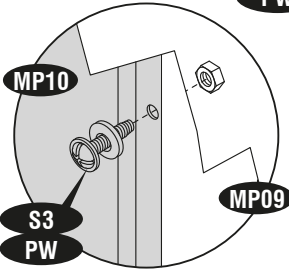

3

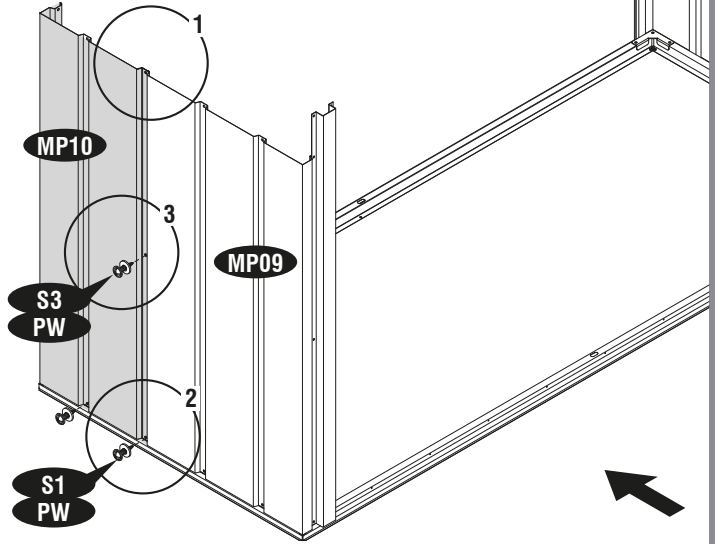

7

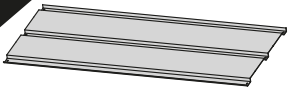

MP08 (x2)



S3 (x2)



S1 (x4)



PW (x6)

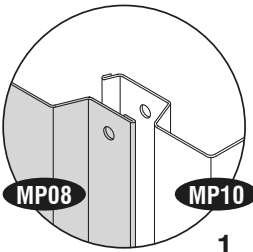
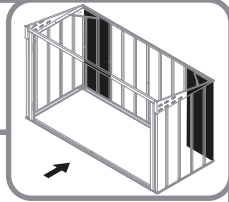

1

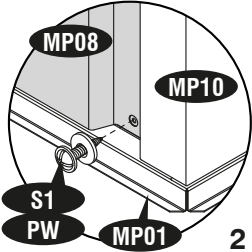

2

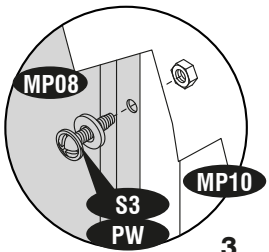

3

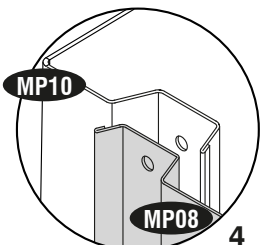

4

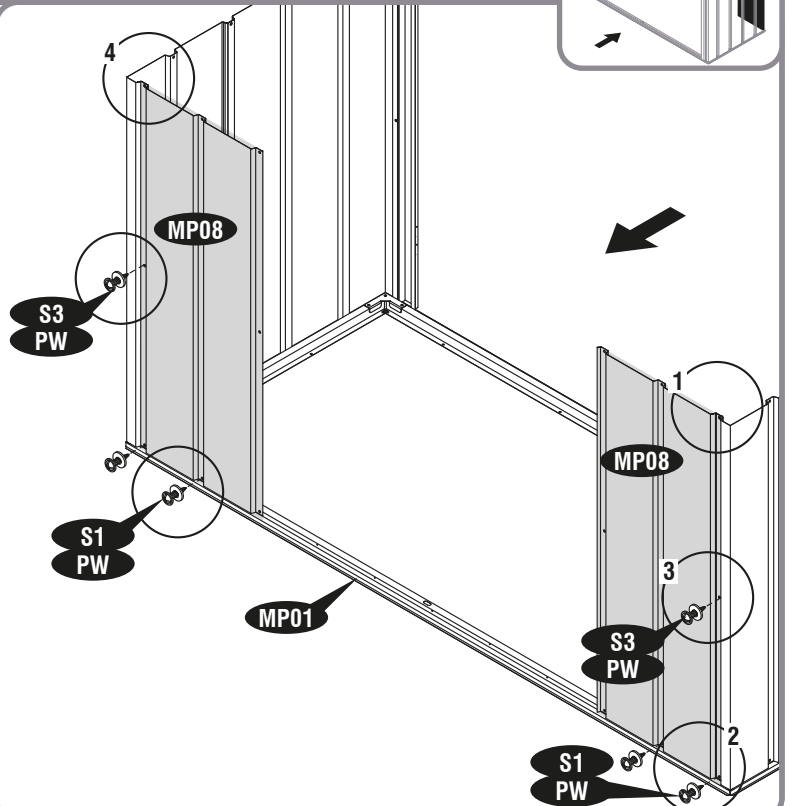

8

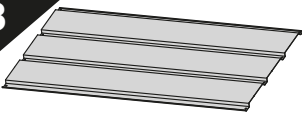

MP07 (x2)

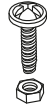

S3 (x3)



S1 (x7)



PW (x10)

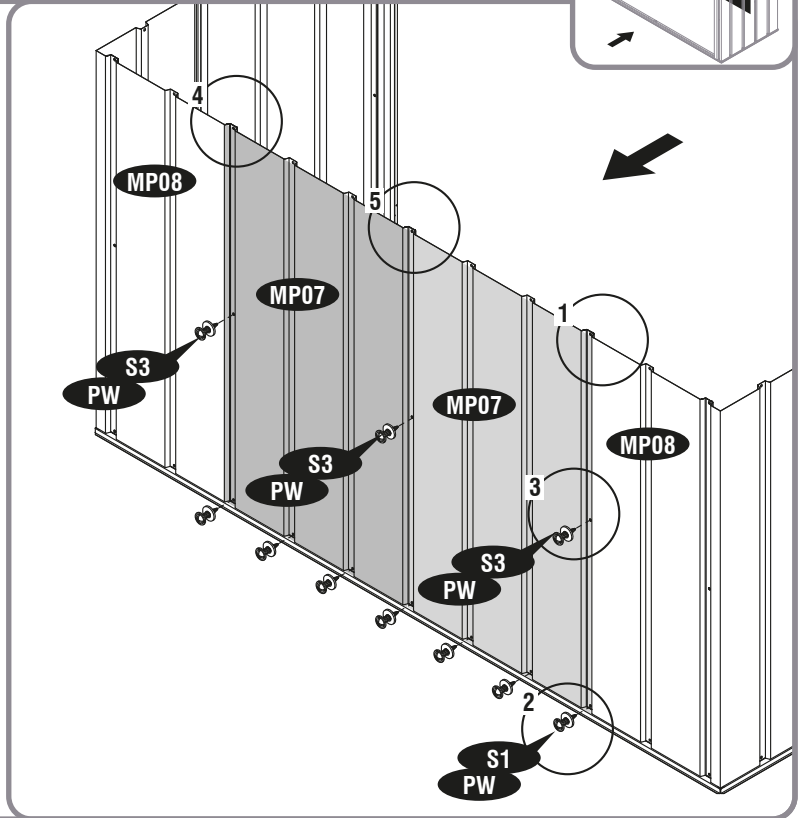
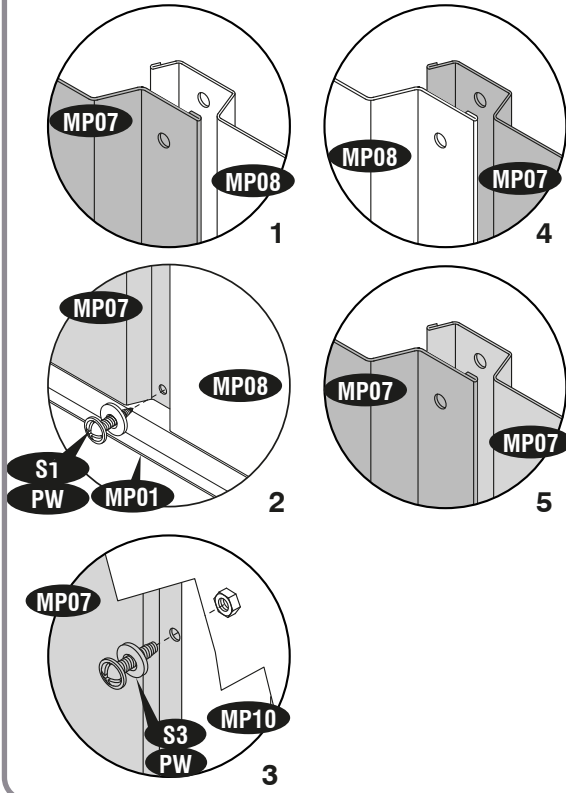
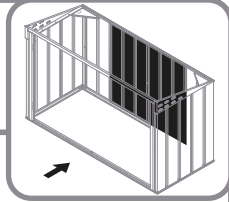

9

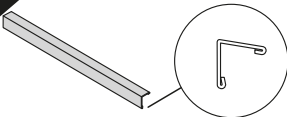

MP03 (x1)



CSLV (x1)



CSRV (x1)



S1 (x2)

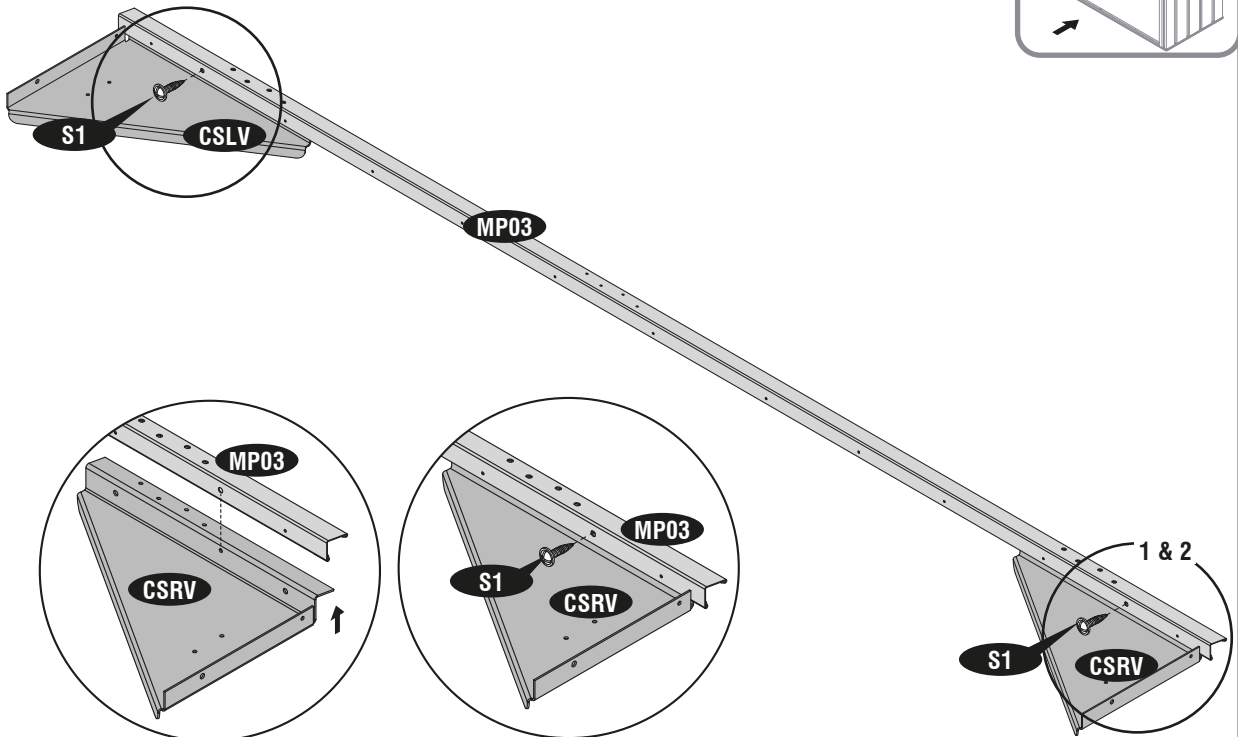
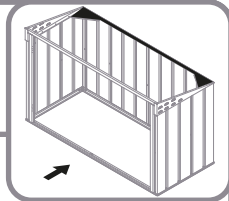

10

S1 (x7)

S2 (x4)

PW (x11)

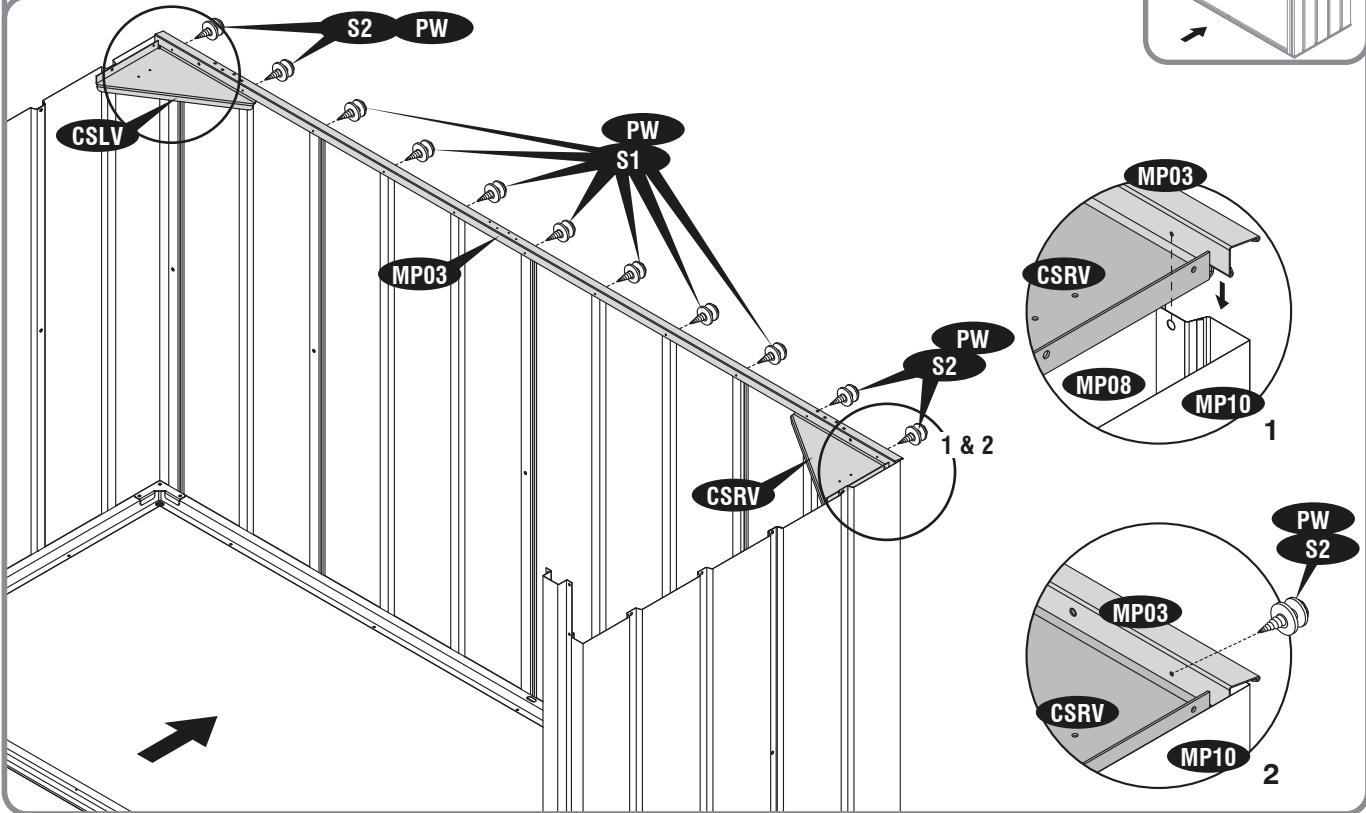
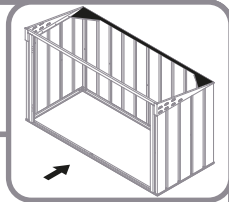

11

ASLV (x1)
ASRV (x1)

S1 (x8)

S2 (x2)

PW (x8)

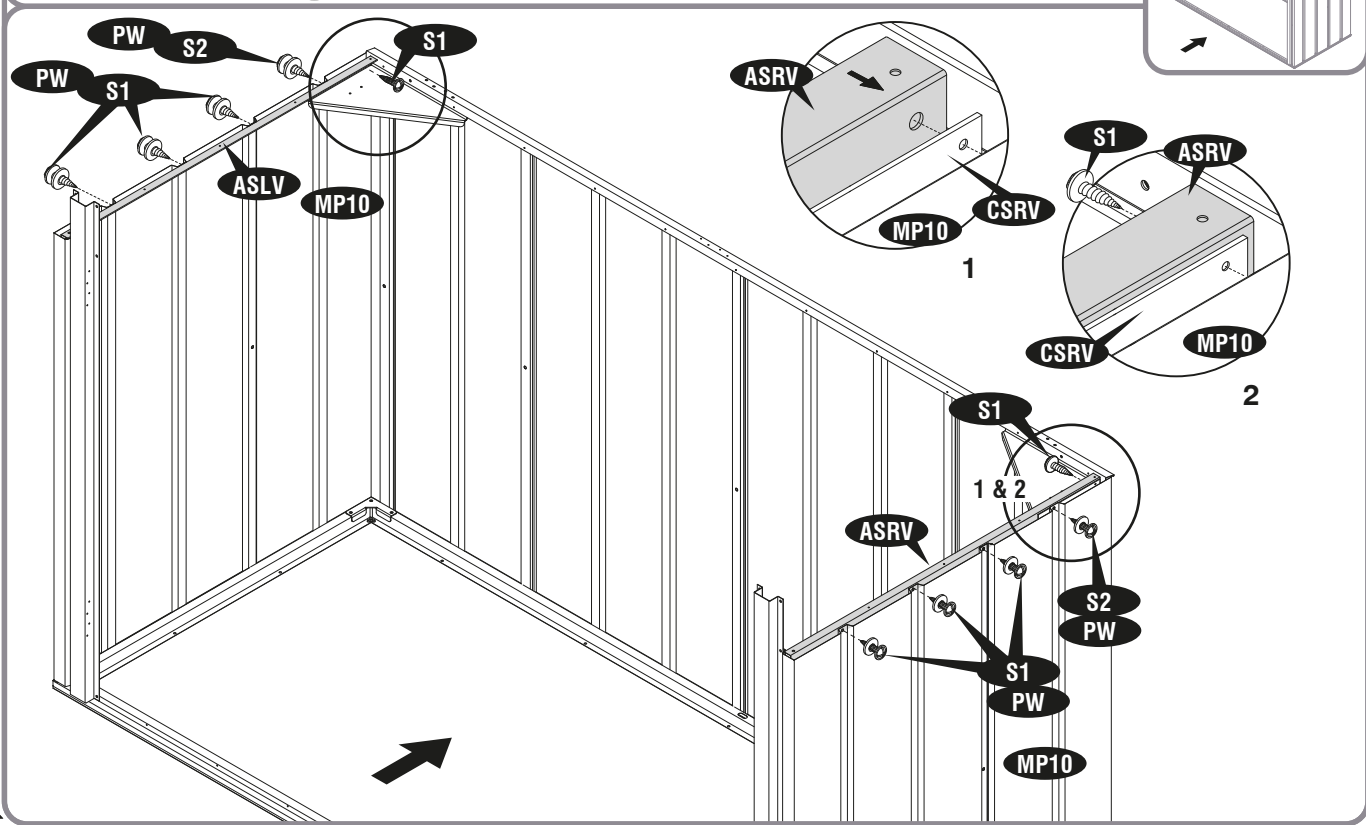
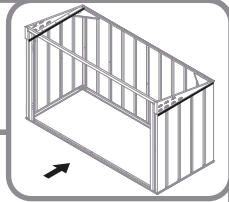

12



MP19 (x1)



S1 (x4)

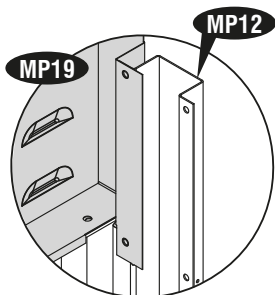

1

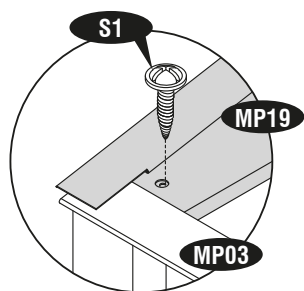

2

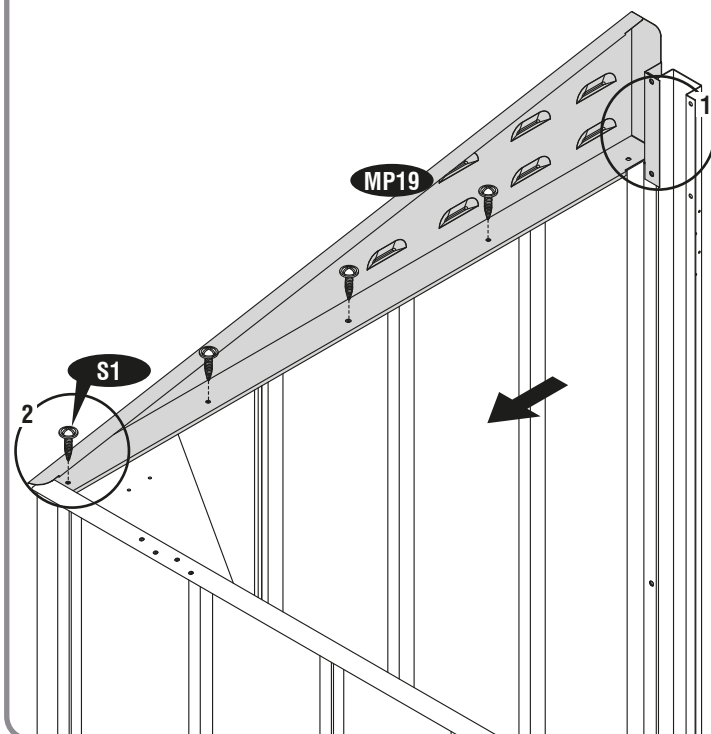

13

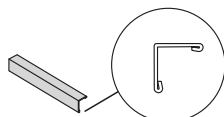

AFV (x1)



S1 (x3)



PW (x2)

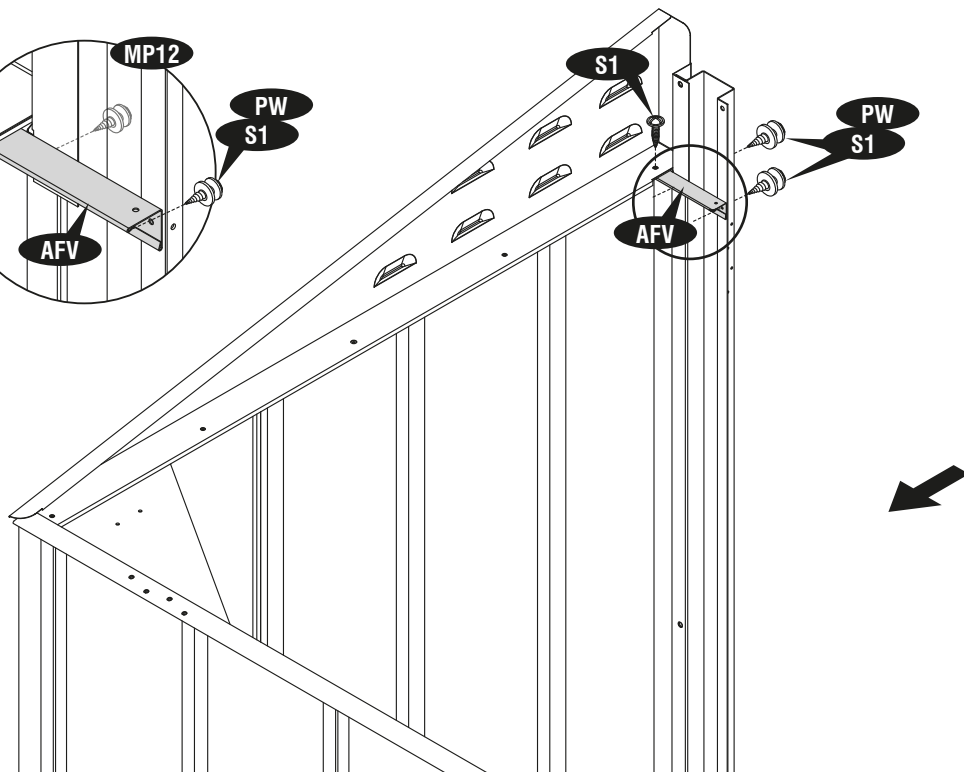
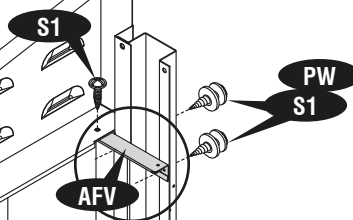
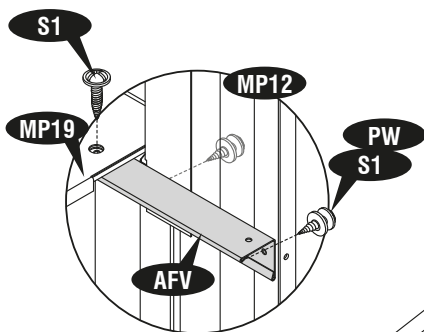
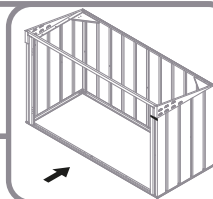

14

MP18 (x1)

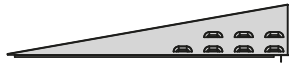

S1 (x4)

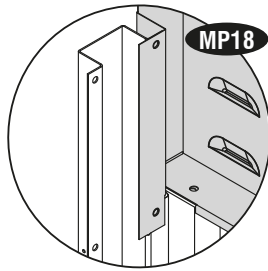
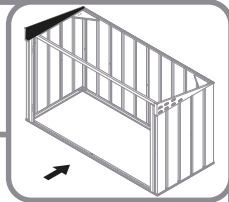

1

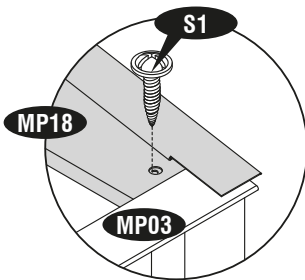

2

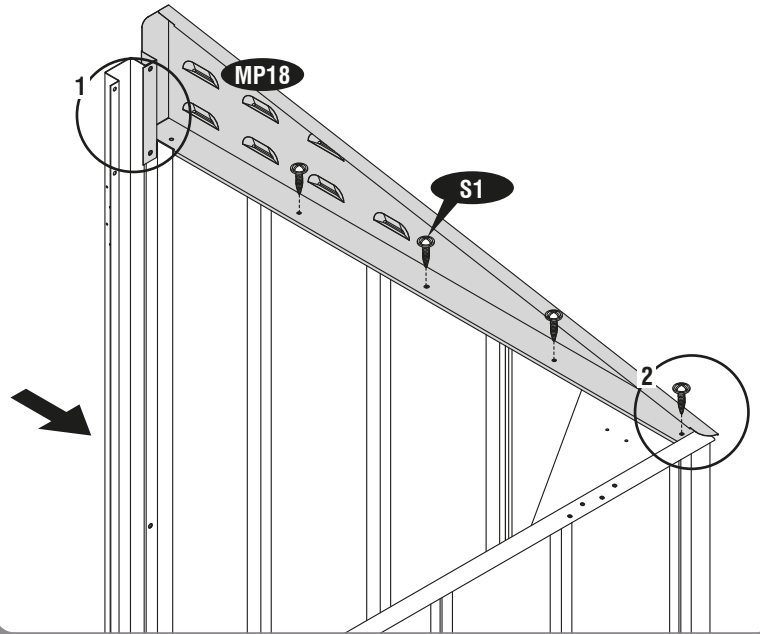

15

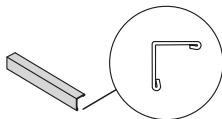

AFV (x1)



S1 (x3)



PW (x2)

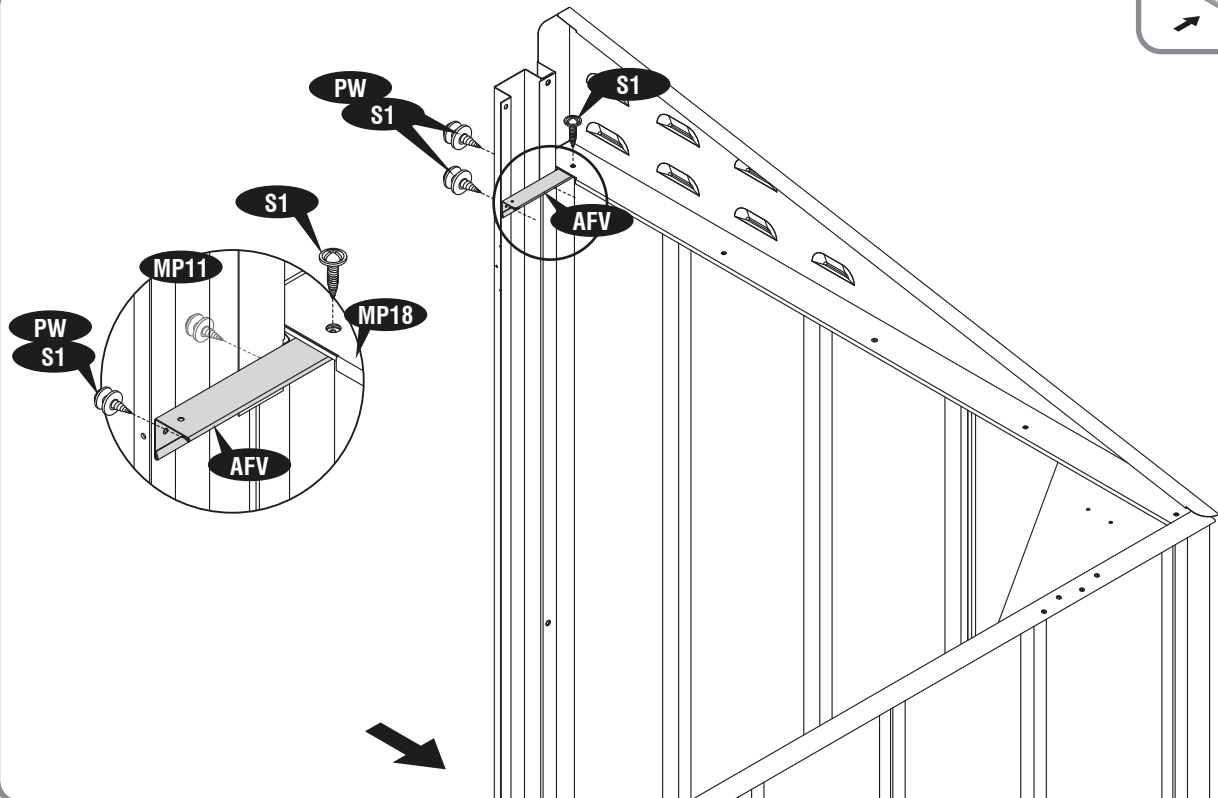
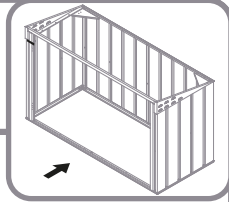

26

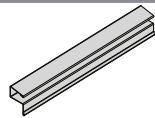

MP14 (x1)

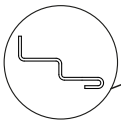

DLFV (x1)



S1 (x5)



PW (x4)

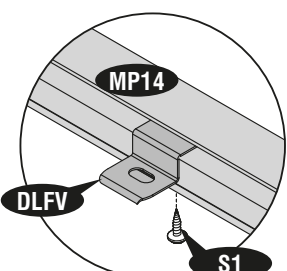
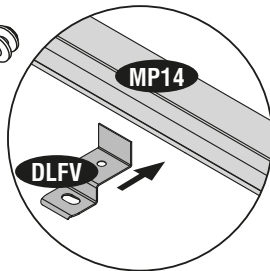
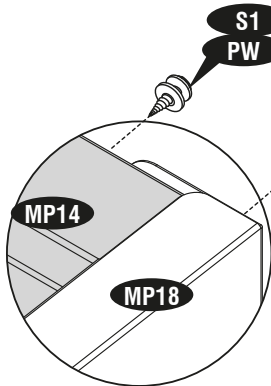
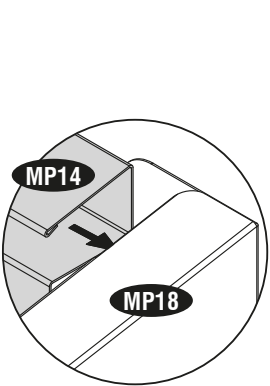
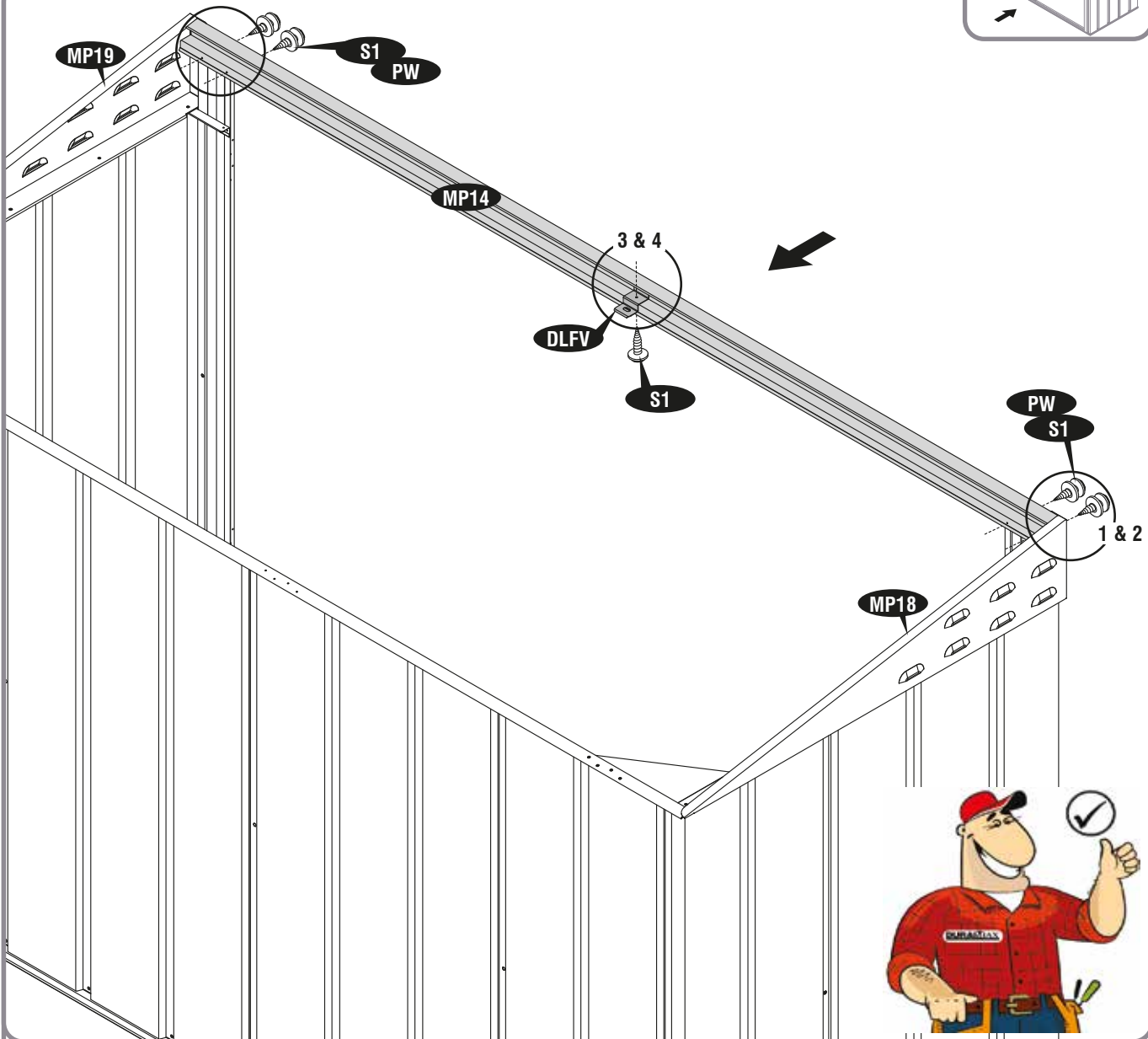
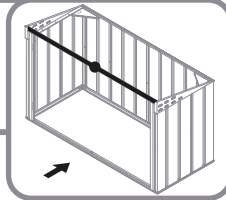



3

EN Front Door
FR Avant Porte
DE Vorne Tür
ES Frente Puerta
PT Frente Porta
NL Vooraan Deur

CS Přední Dveře
SK Predné Dvere
SL Prednja Vrata
HR Prednja vrata
HU Bejárati Ajtó
SV Framsida Dörr

IT Frontale Porta
PL Przód Drzwi
RO Frontală Uşa
BG Предна Врата
TR Ön Kapı

EN Parts needed

FR Pièces nécessaires

DE Benötigte Teile

ES Piezas necesitadas

PT Peças Necessárias

NL Onderdelen nodig

CS Potřebné součásti

SK Potrebne časti

SL Dele, ki jih boste potrebovali

HR Dijelovi potreban

HU Szükséges részek

SV Delar som behövs

IT Parti occorrenti

PL Niezbędne elementy

RO Elementele componente necesare

BG Необходими части

TR Gerekli parçalar

MP06	4
MP13	1
MP16	1
MP17	1

MP20	1
DHBT	4
DHT	4
DLT	1

TB	2
S1	42
S2	32
PW	16

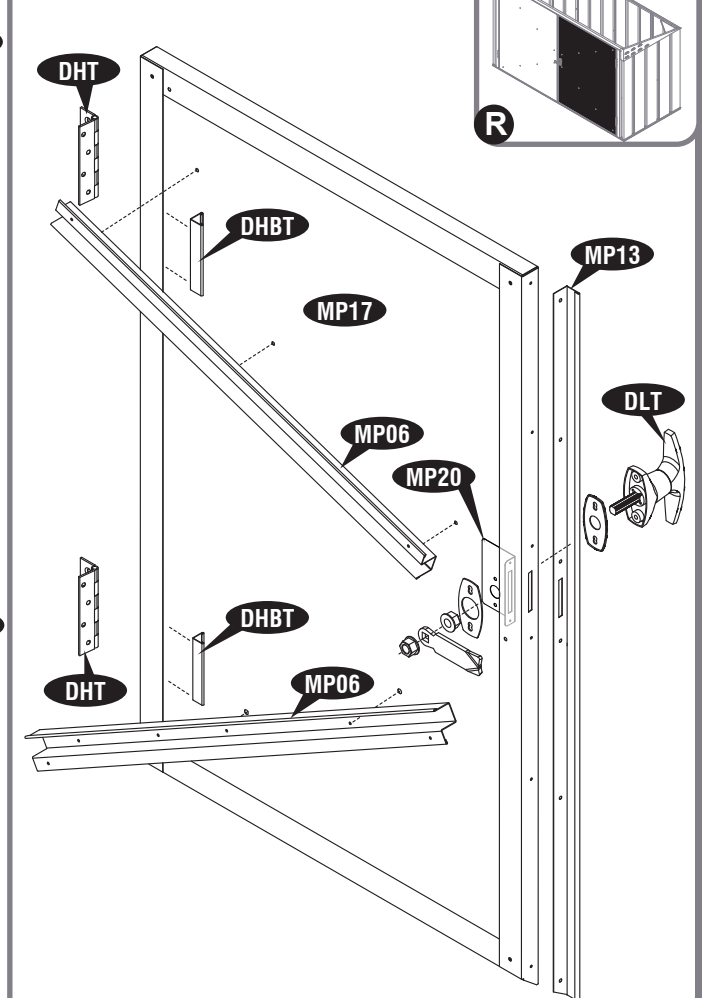
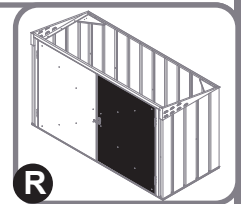
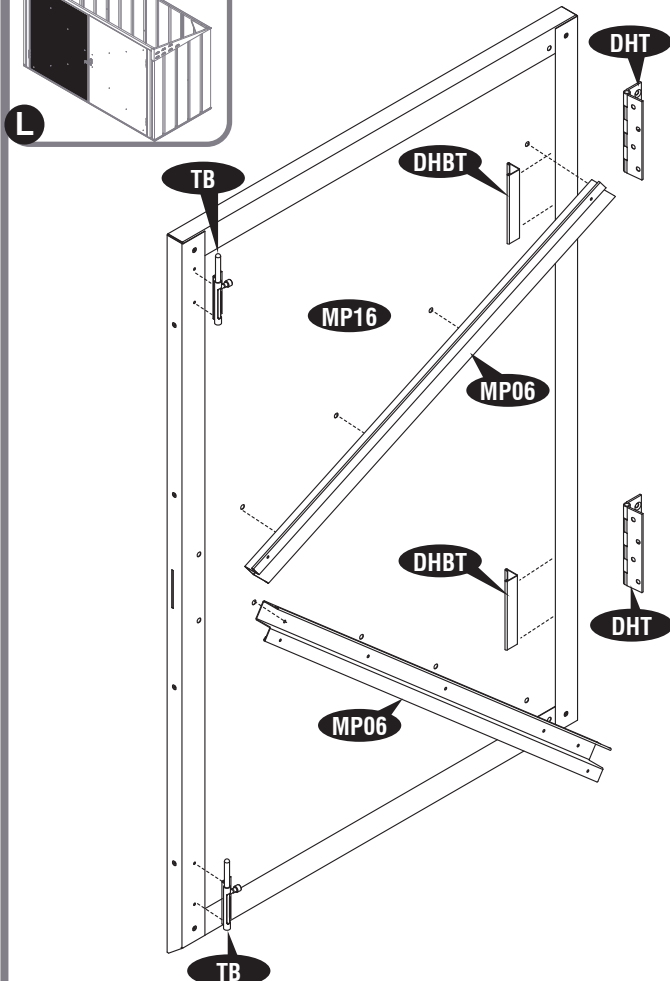
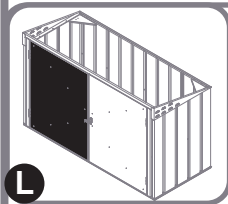

1

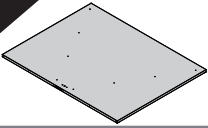

MP17 (x1)



S1 (x4)

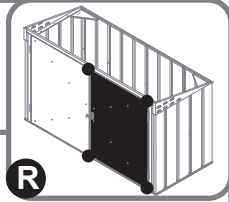

R

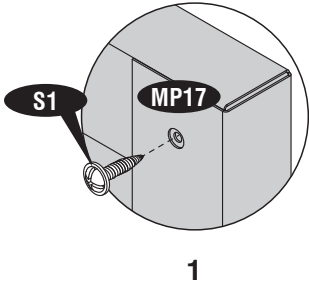
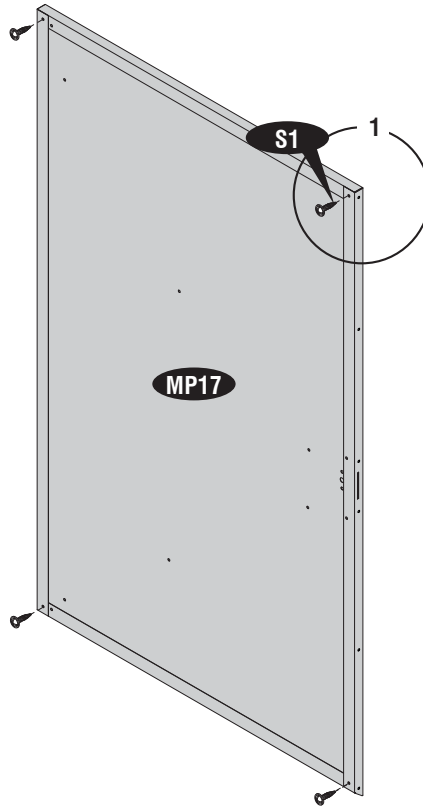

1



2

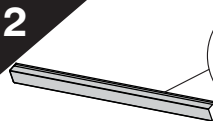

MP13 (x1)

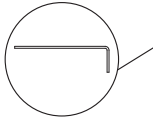

MP20 (x1)



S1 (x6)

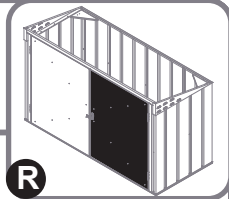

R

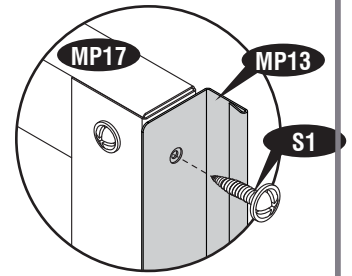
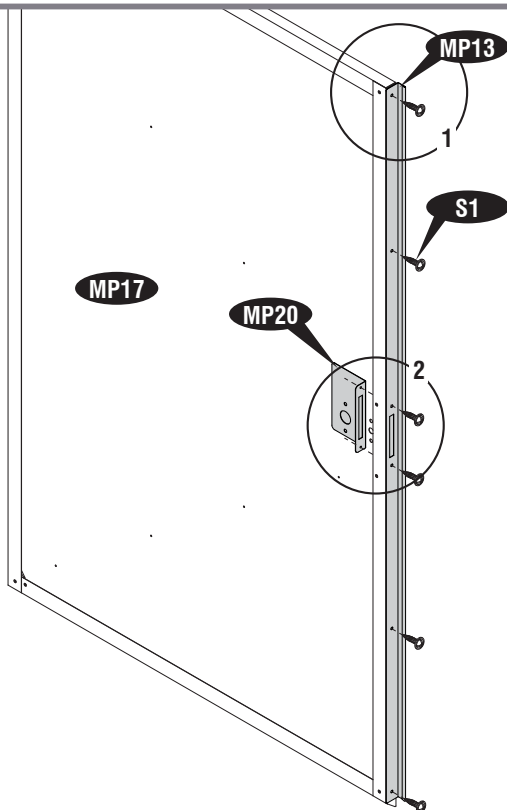

1

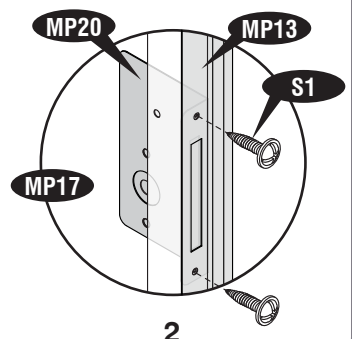

2

5

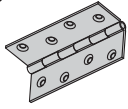

DHT (x2)

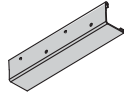

DHBT (x2)



S2 (x8)

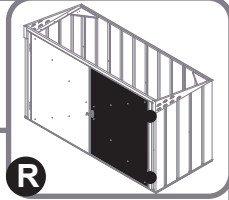

R

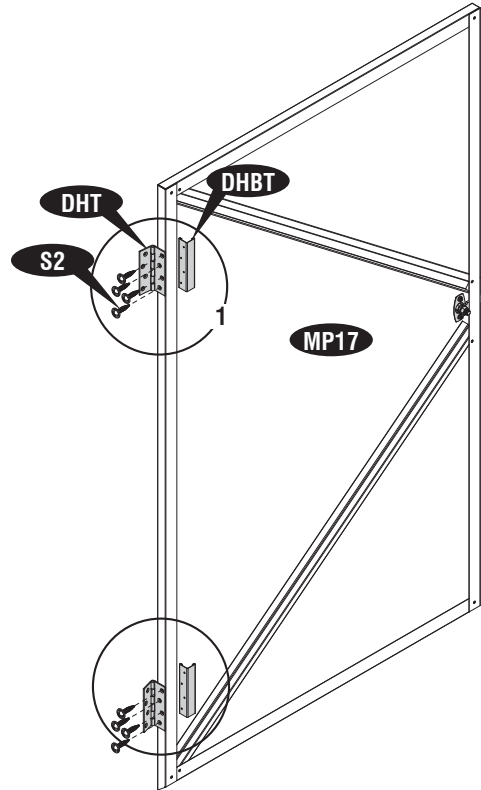
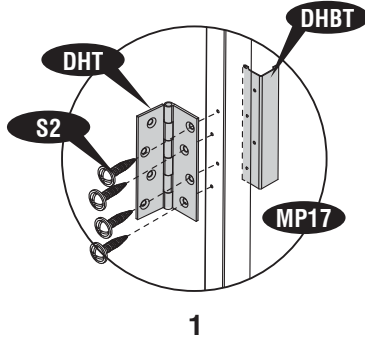

6

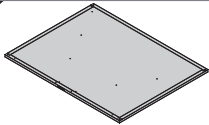

MP16 (x1)



S1 (x4)

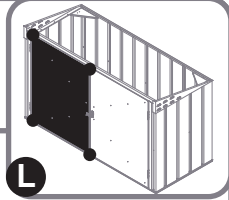

L

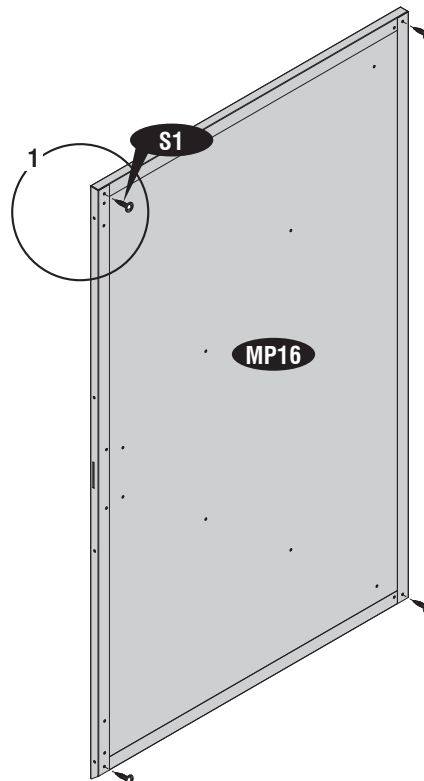
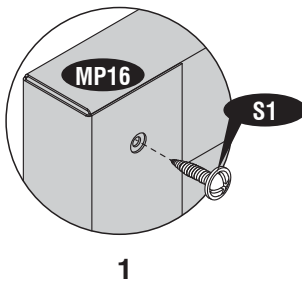

7

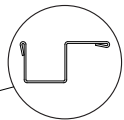
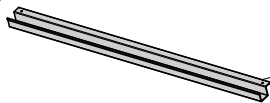

MP06 (x2)



S1 (x12)



PW (x8)

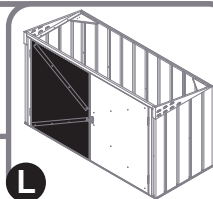

L

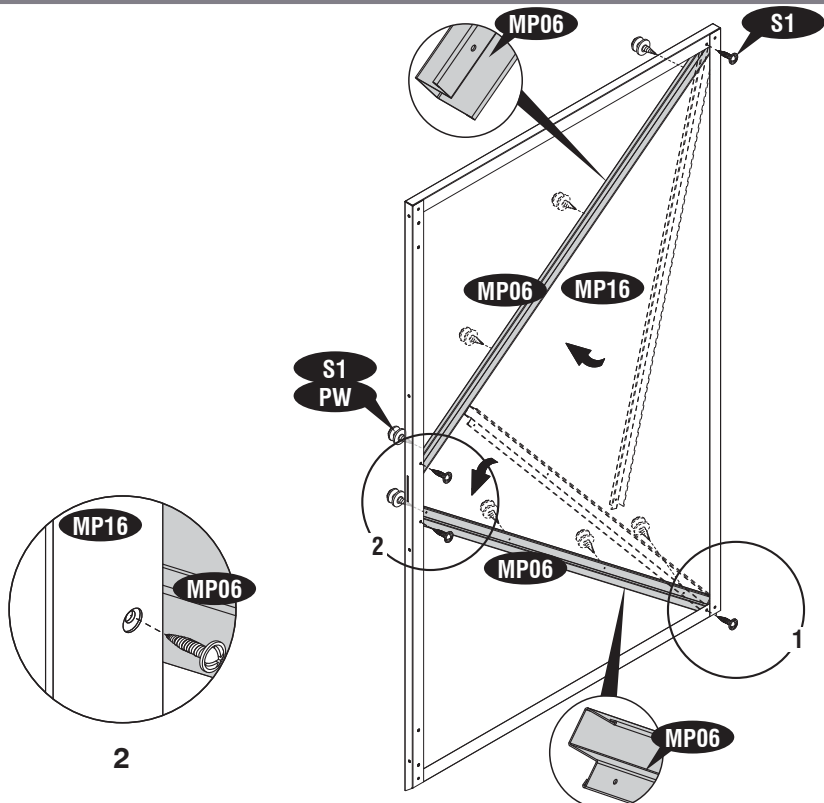

8

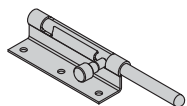

TB (x2)



S1 (x4)



L

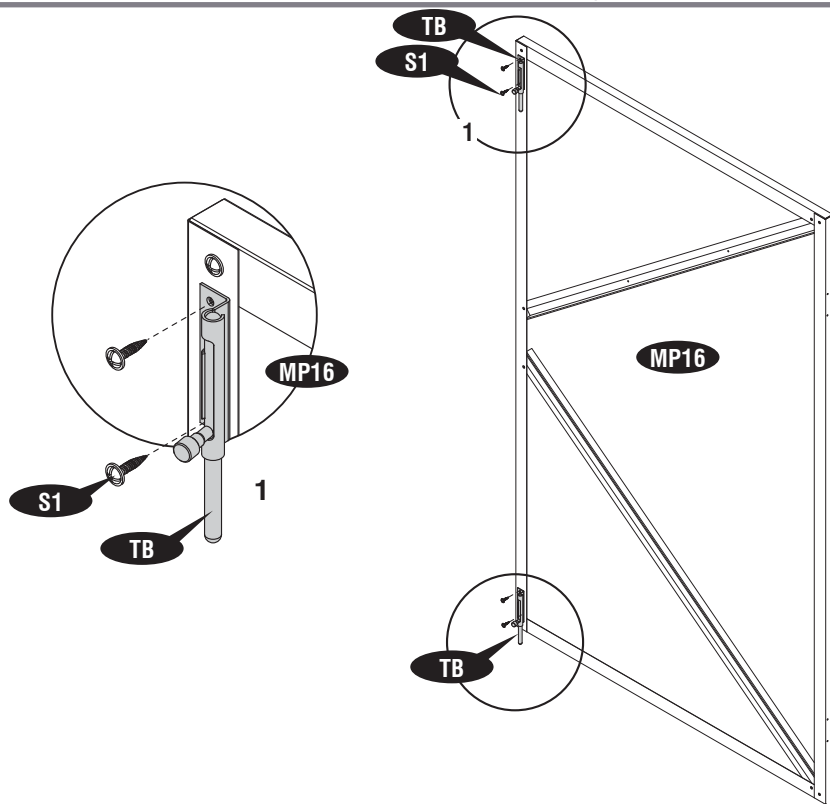

9

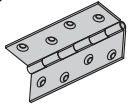

DHT (x2)

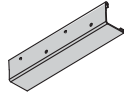

DHBT (x2)



S2 (x8)

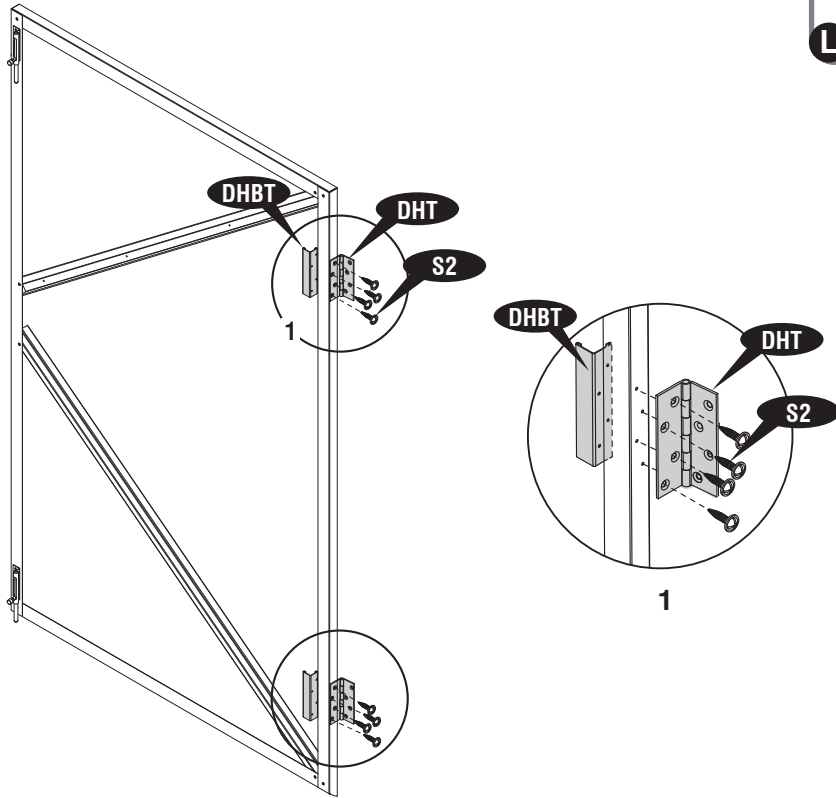
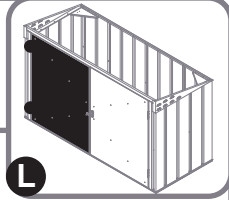

10



S2 (x8)

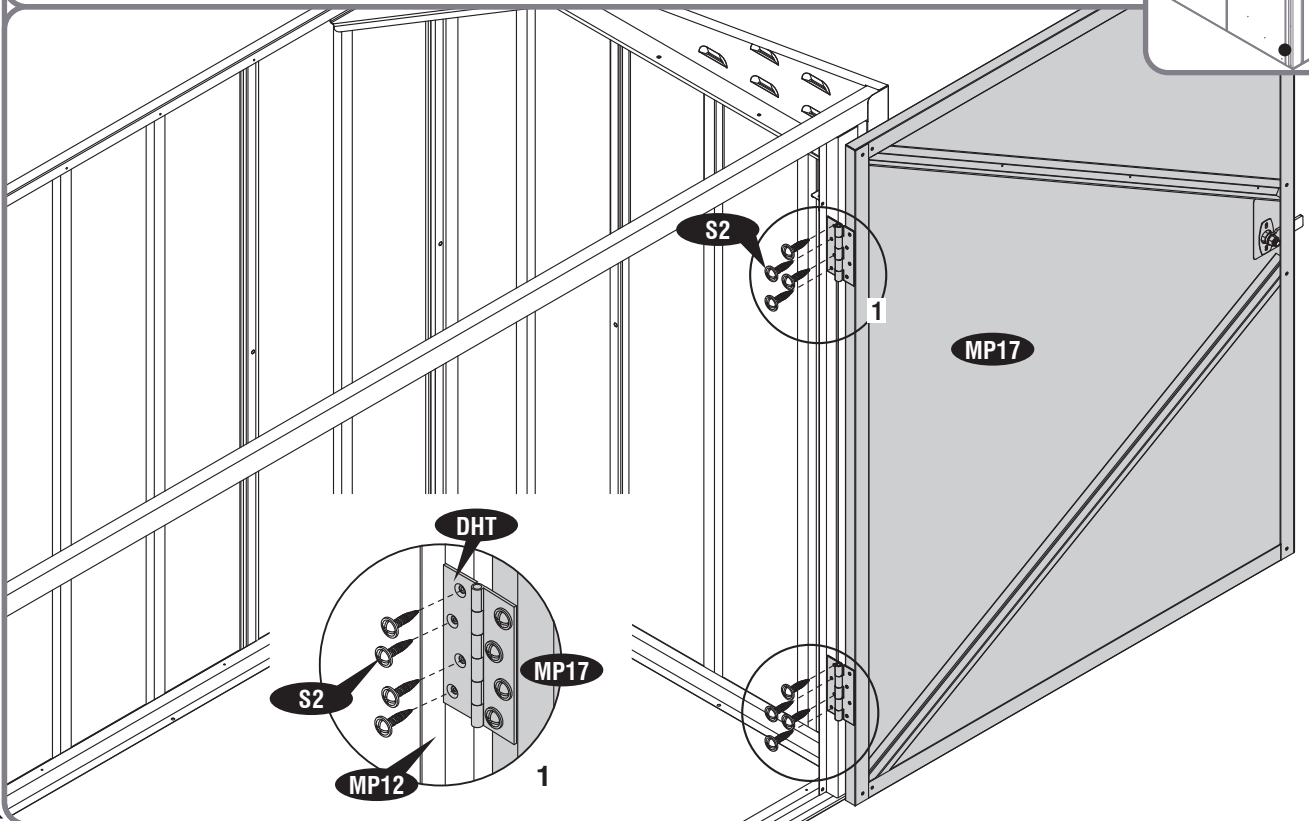
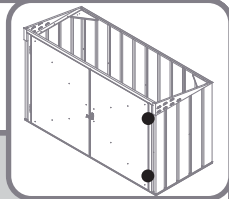

33

 S2 (x8)

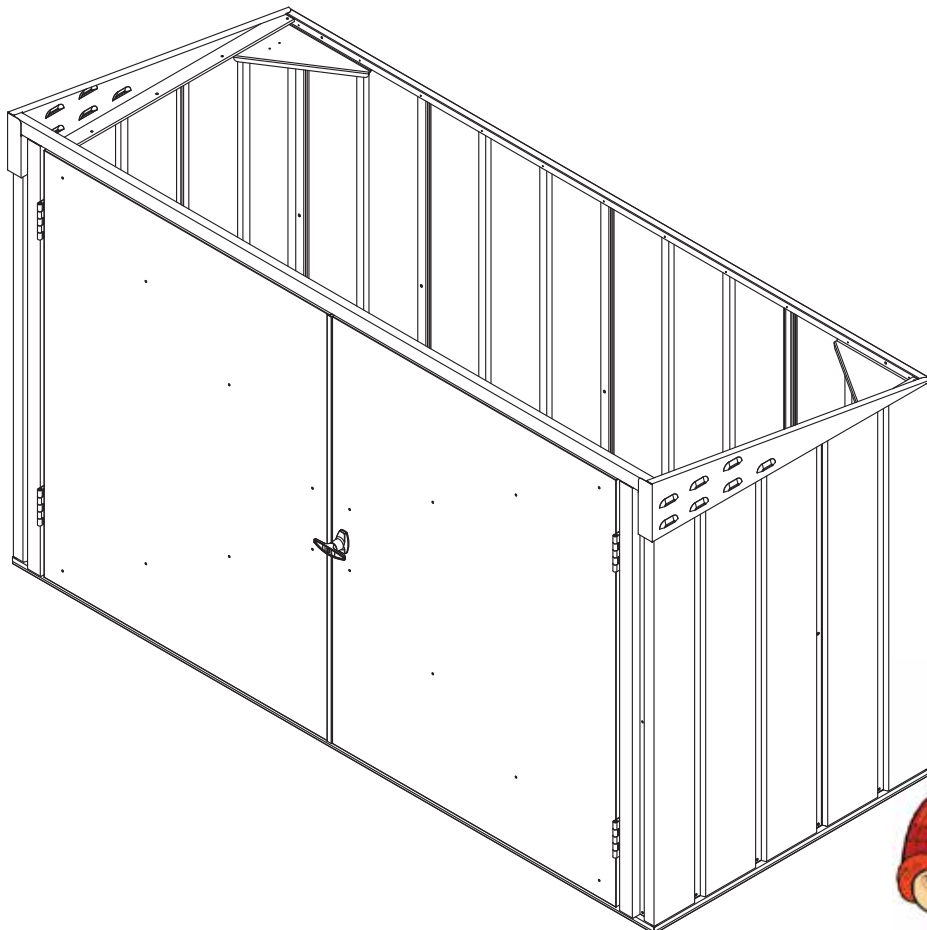
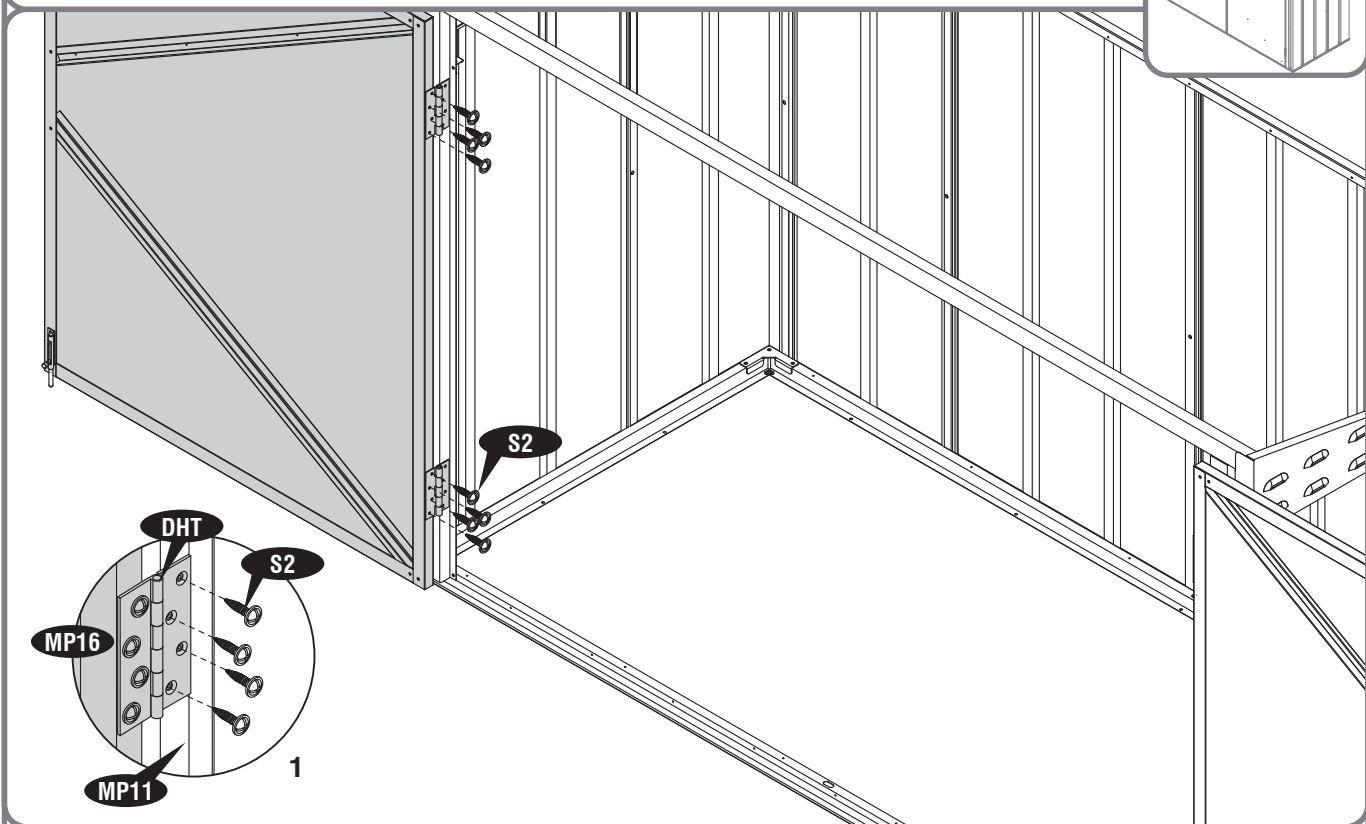
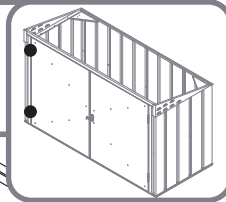



4

- | | |
|------------------------------------|------------------------------------|
| (EN) Top Door Assembly | (HR) Sklop Gornjih Vrata |
| (FR) Assemblage De Porte Supérieur | (HU) Felső Ajtó Szerelés |
| (DE) Spitzentür-zusammenbau | (SV) Övre Dörren Församling |
| (ES) Asamblea De Puerta Superior | (IT) Montaggio Sportello Superiore |
| (PT) Reunião De Porta Superior | (PL) Zespół Górnych Drzwi |
| (NL) Bovenste Deur Vergaderingz | (RO) Top Usa Montaj |
| (CS) Horní Dveře Shromáždění | (BG) Монтаж На Горната Врата |
| (SK) Top Dvere Montáž | (TR) Üst Kapı Montajı |
| (SL) Sestava Zgornjih Vrat | |

- | | | |
|-------------------------|-------------------------------------|-------------------------------------|
| (EN) Parts needed | (CS) Potřebné součásti | (IT) Parti occorrenti |
| (FR) Pièces nécessaires | (SK) Potrebné časti | (PL) Niezbędne elementy |
| (DE) Benötigte Teile | (SL) Dele, ki jih boste potrebovali | (RO) Elementele componente necesare |
| (ES) Piezas necesarias | (HR) Dijelovi potreban | (BG) Необходими части |
| (PT) Peças Necessárias | (HU) Szükséges részek | (TR) Gerekli parçalar |
| (NL) Onderdelen nodig | (SV) Delar som behövs | |

MP04	2	TDFV	3	S1	62
MP05	1	C01V	2	S2	24
MP15	1	CHV	3	S17	6
CDFV	4	DHT	3	PW	38
CSTV	2	TB	1		
HSPV	3	TC	4		

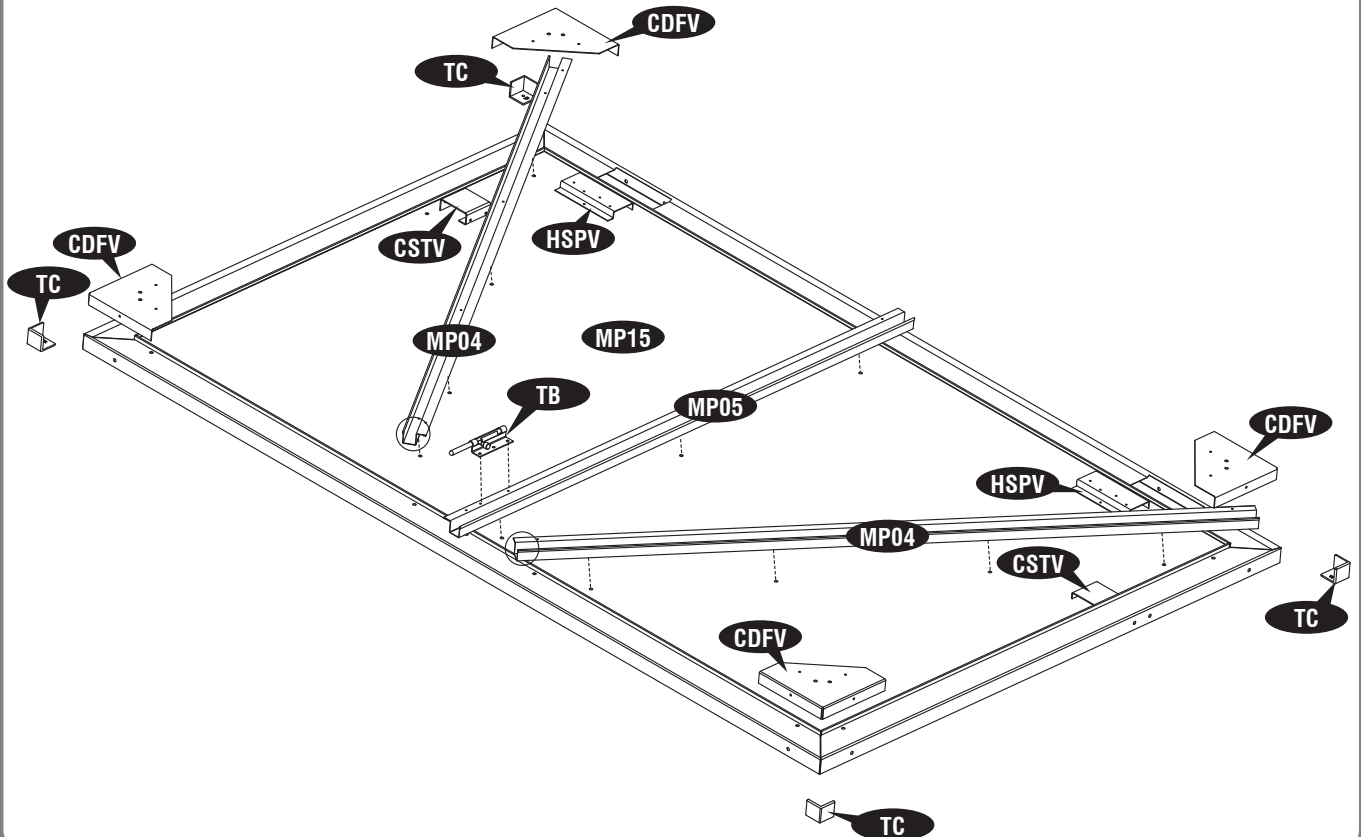
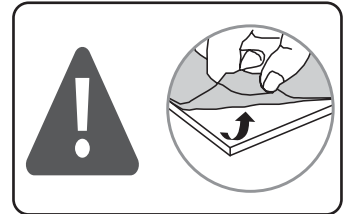

1

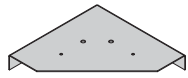

CDFV (x4)



S1 (x16)



PW (x16)

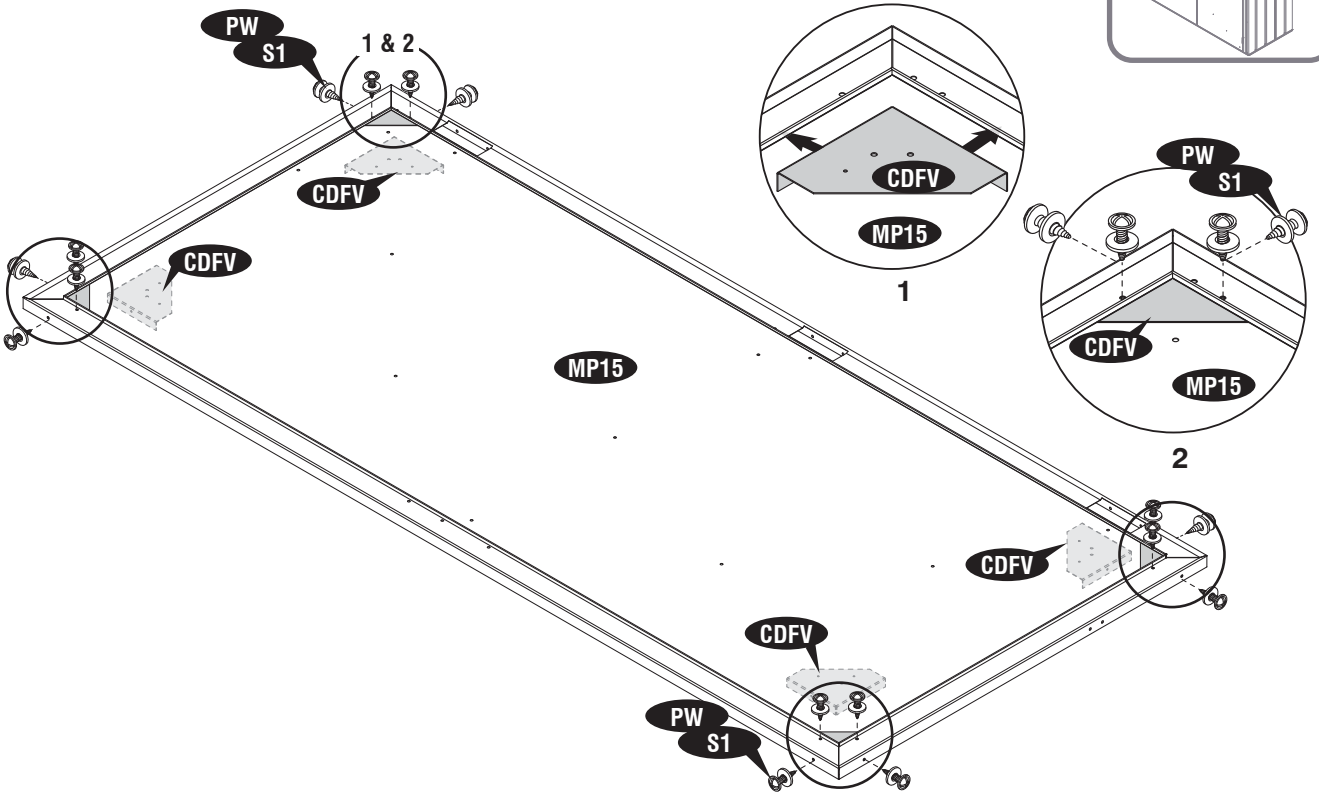
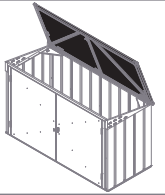

2

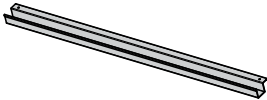

MP04 (x2)
MP05 (x1)



S1 (x17)



PW (x17)

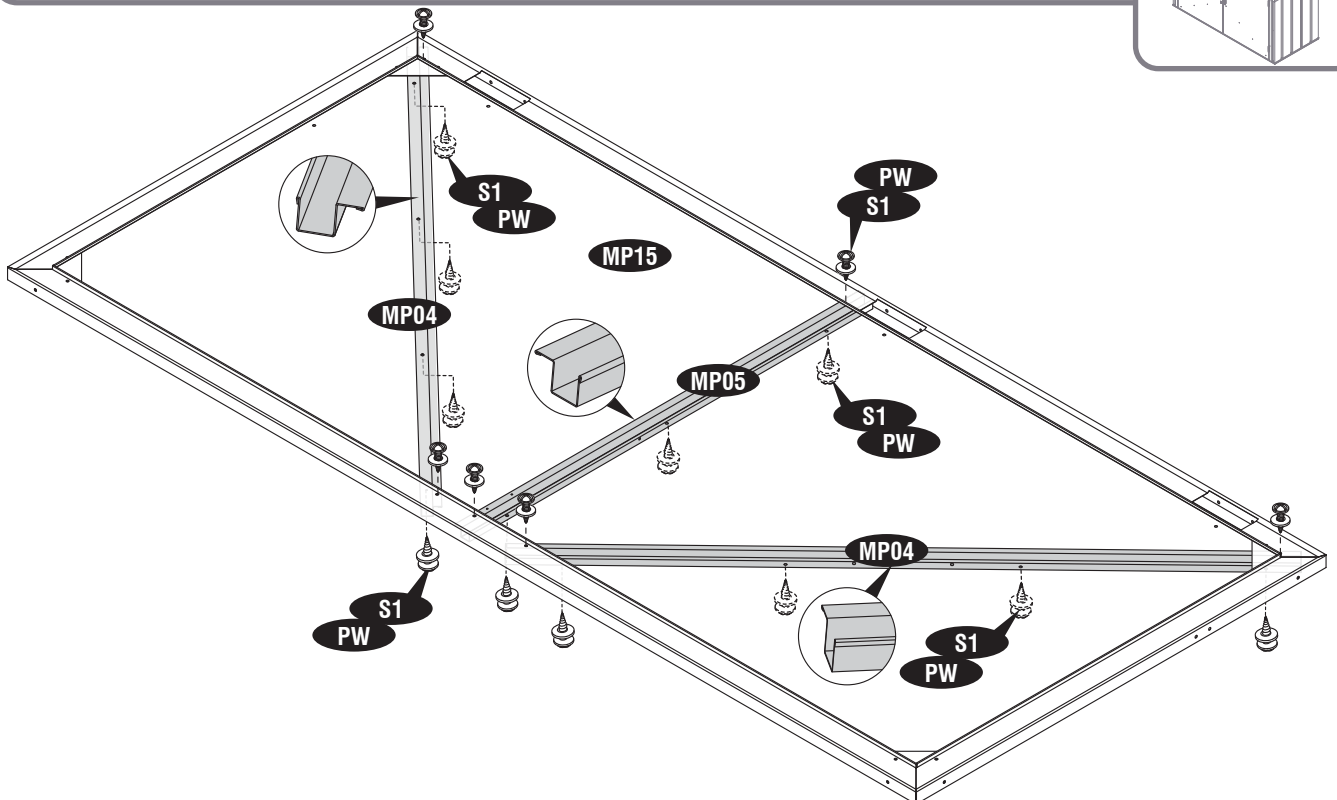
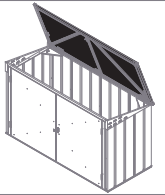

3



CSTV (x2)



HSPV (x3)



S1 (x15)



PW (x15)

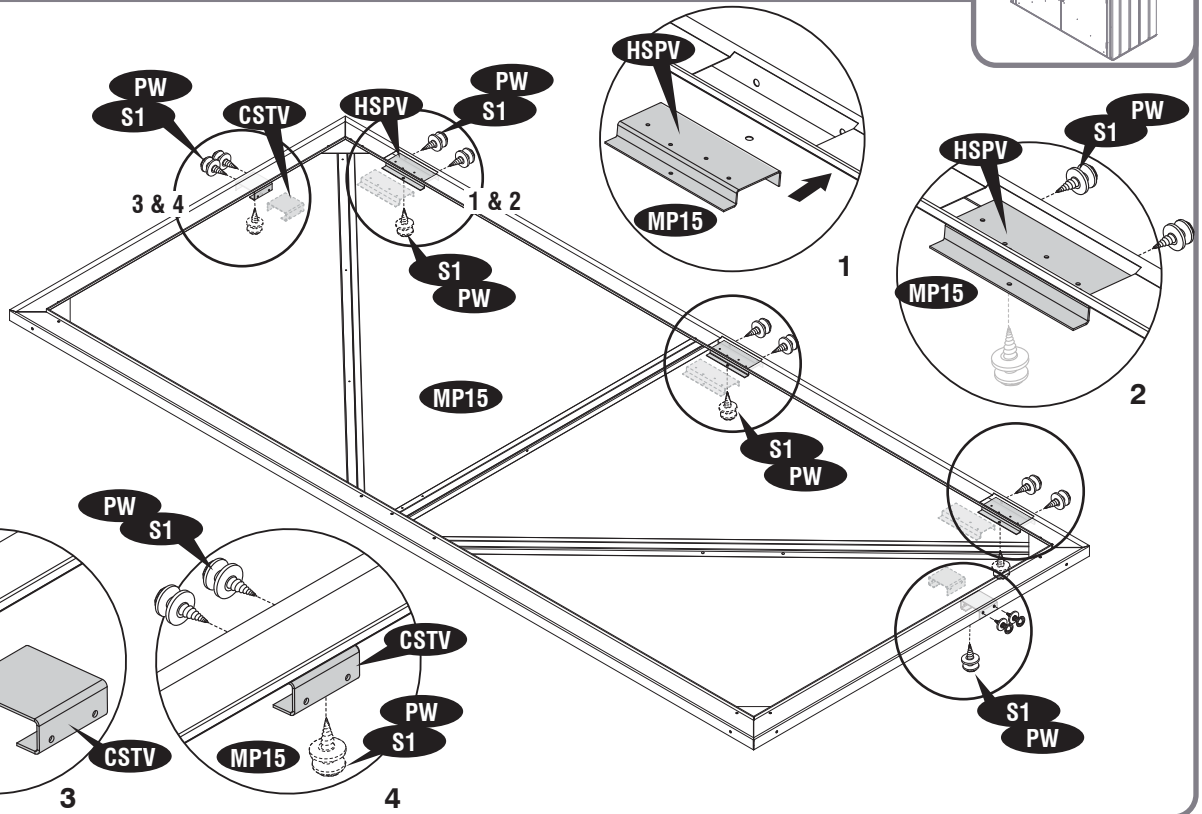

4

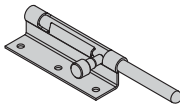

TB (x1)



S1 (x2)

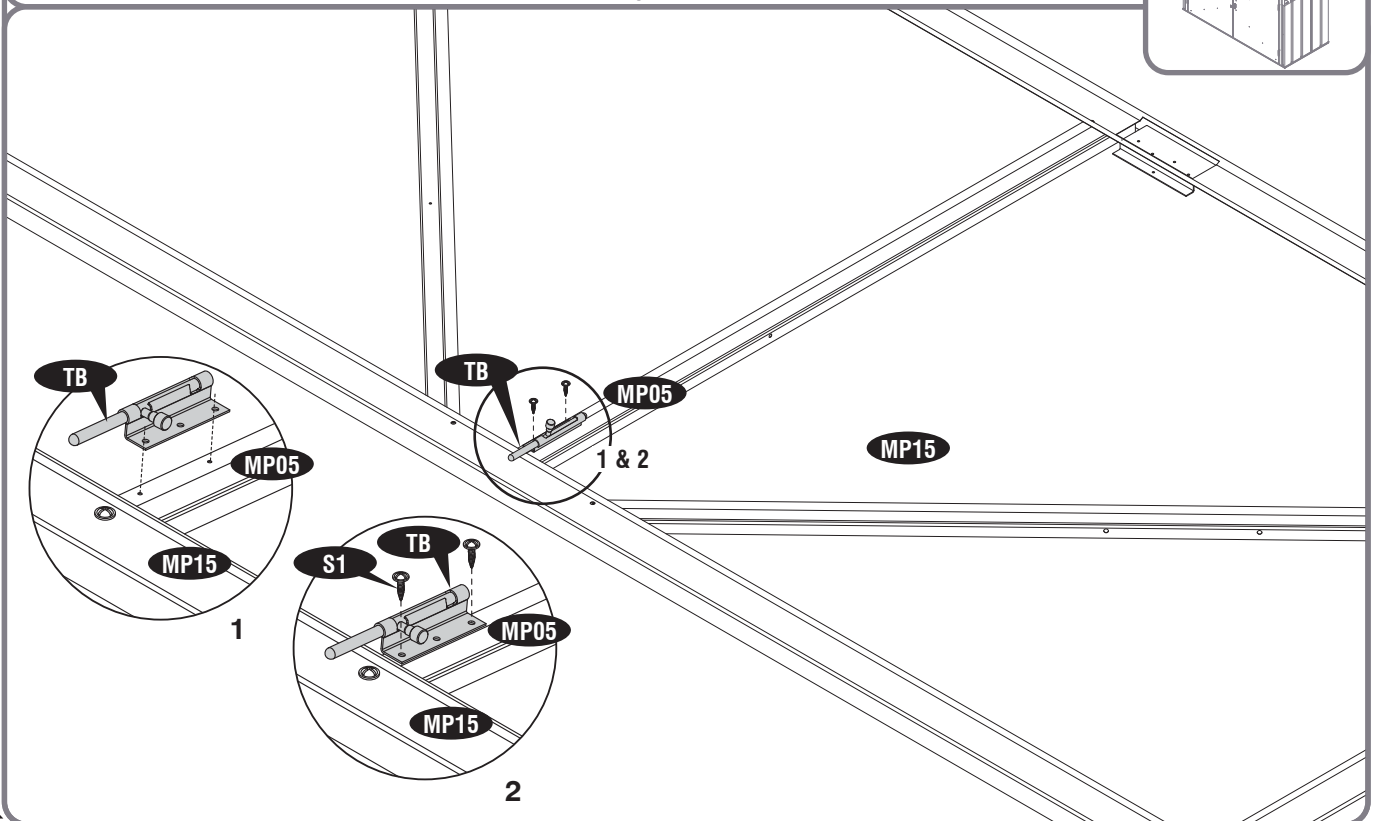
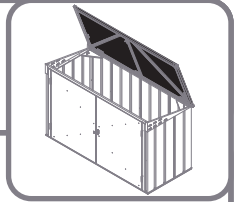

5

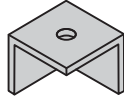

TC (x4)



S2 (x4)

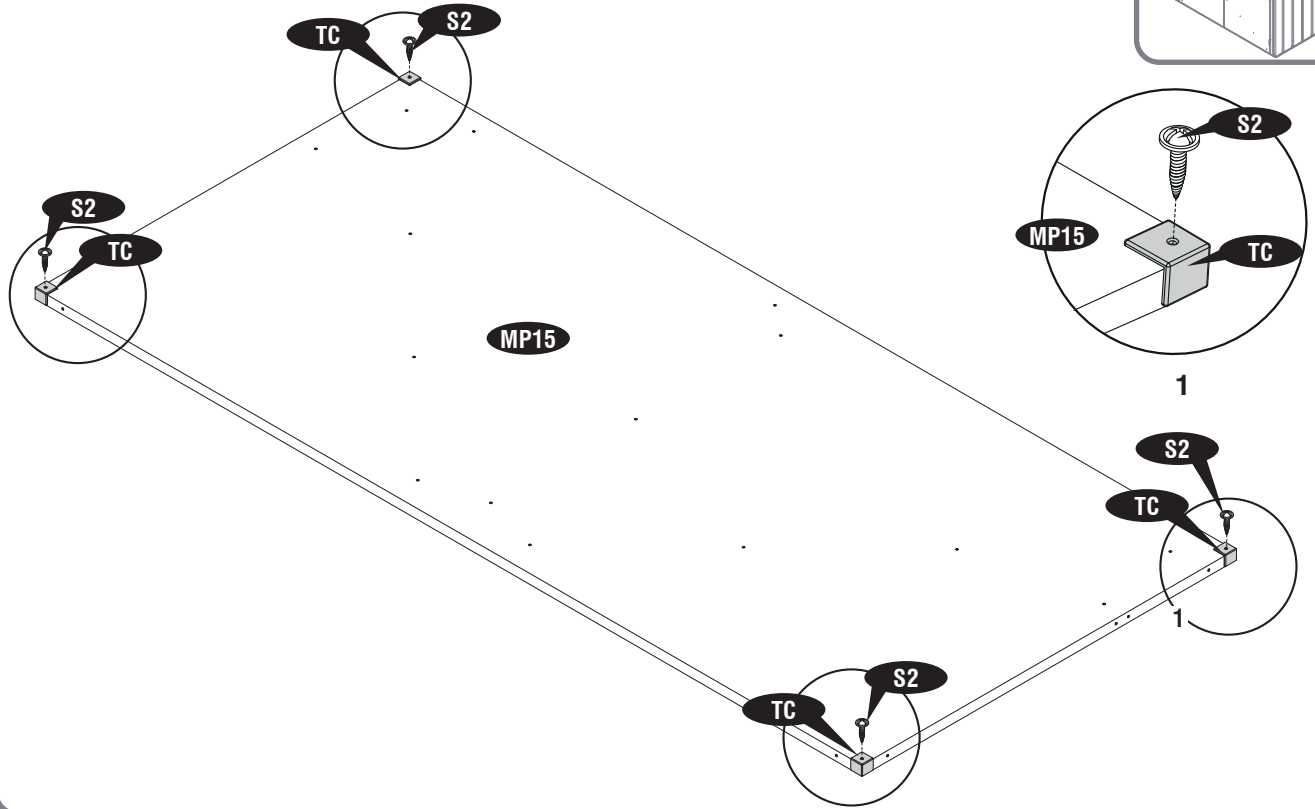
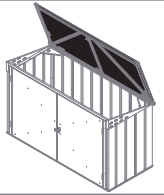

6

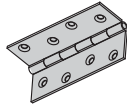

DHT (x3)



S2 (x12)

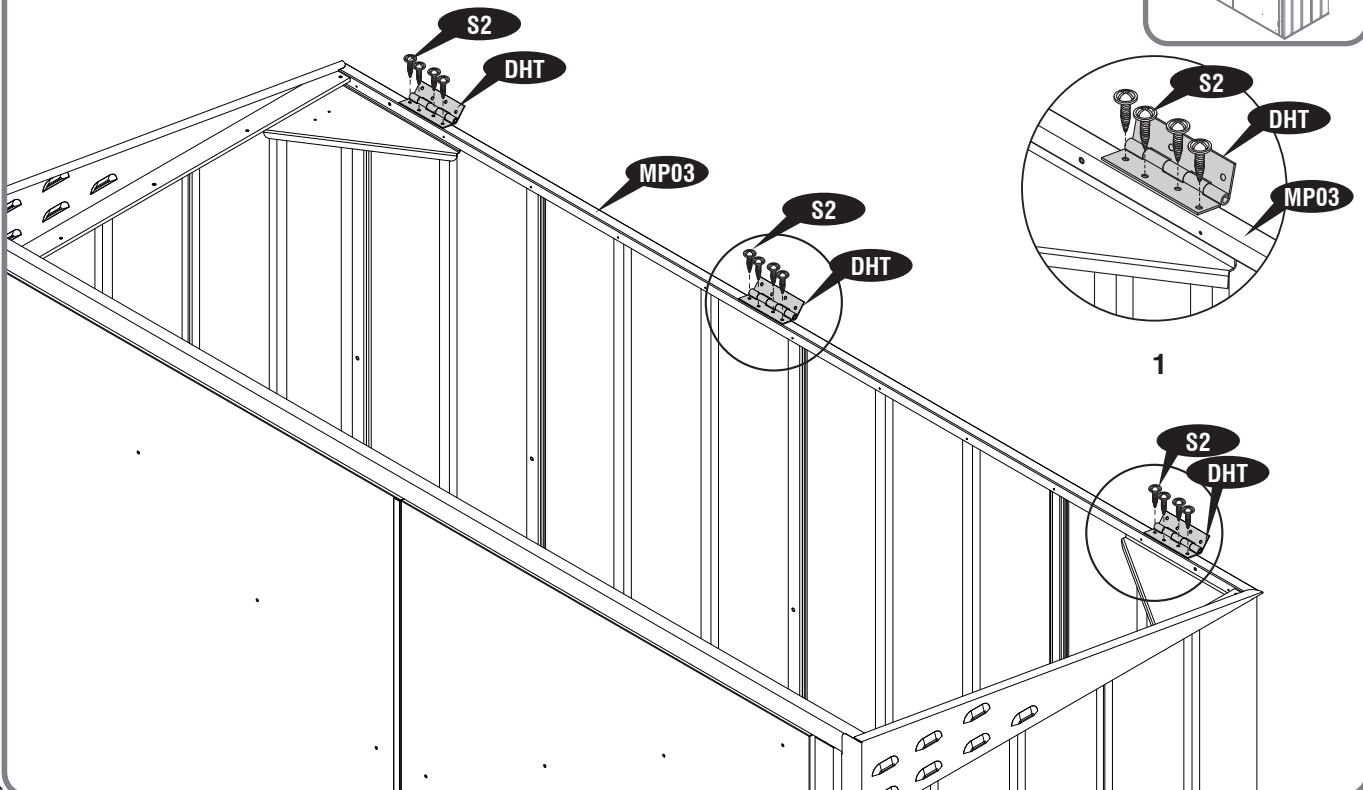

7

S1 (x12)

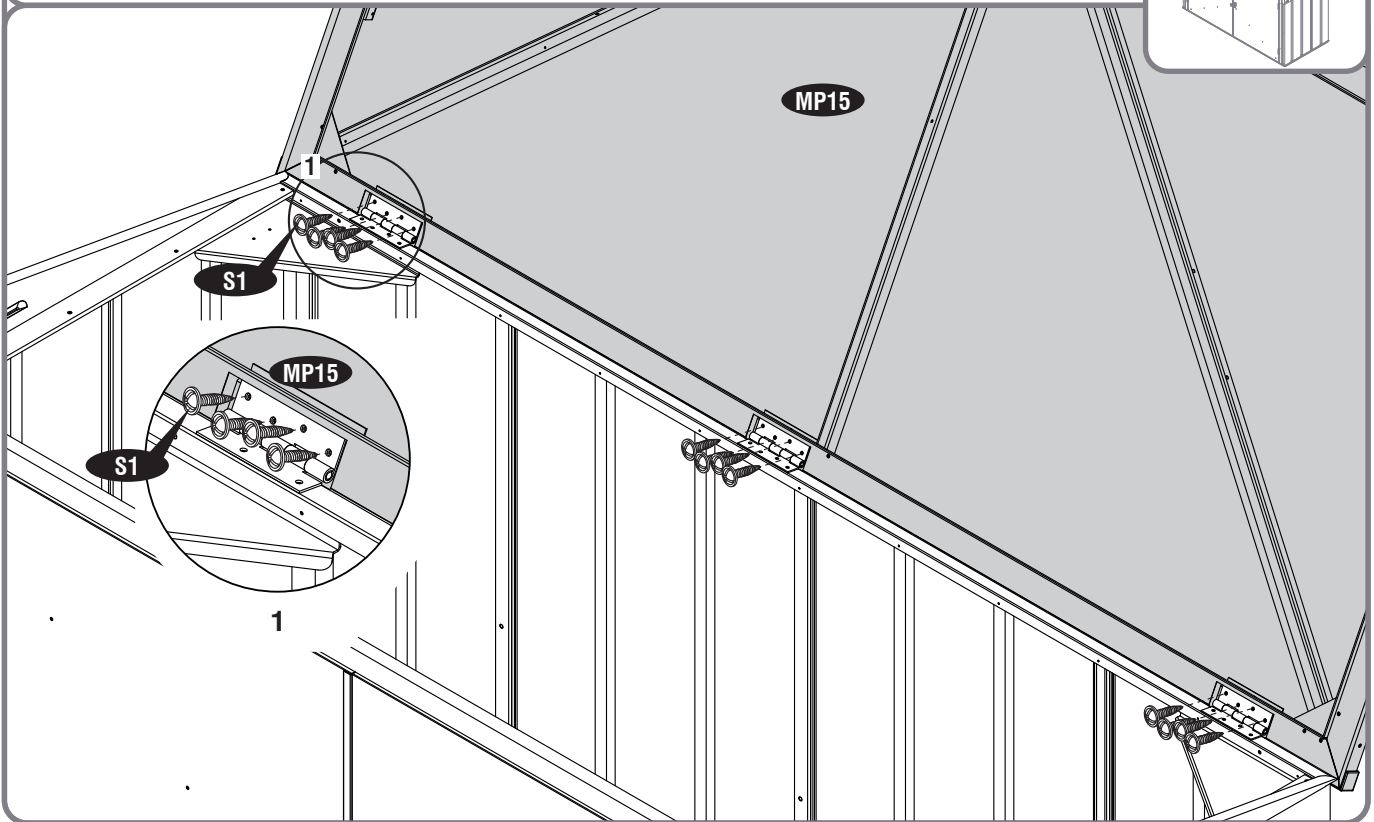
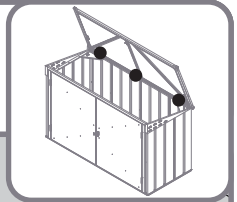

8

C01V (x2)

S2 (x8)

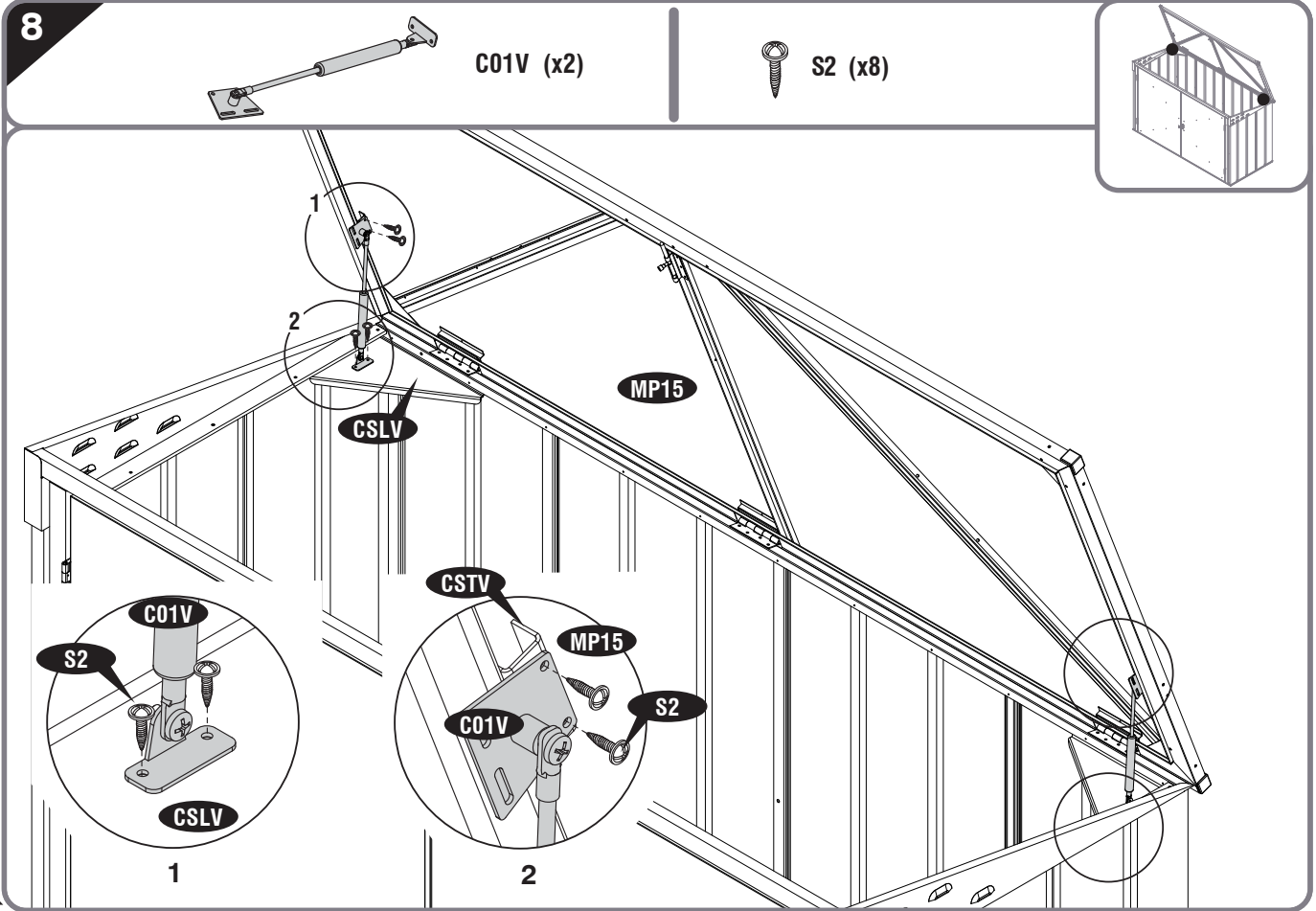
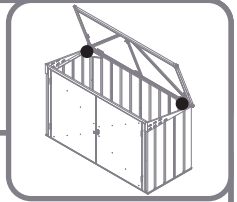

9



TDFV (x3)



CHV (x3)



S17 (x6)

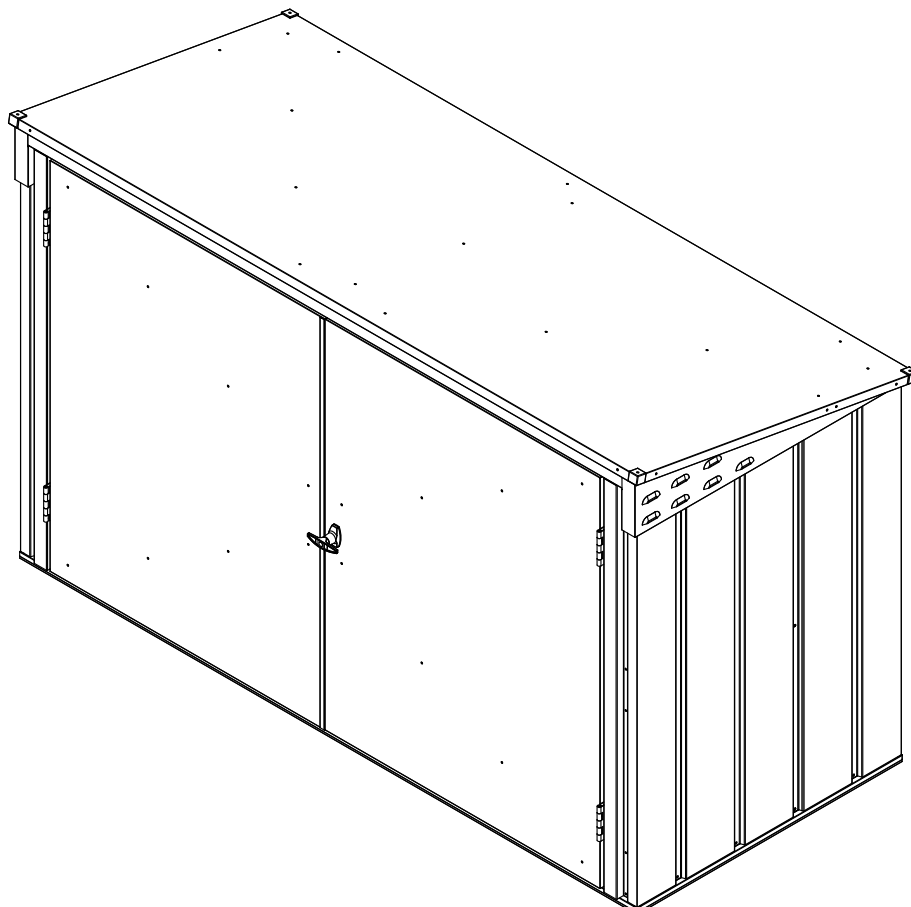
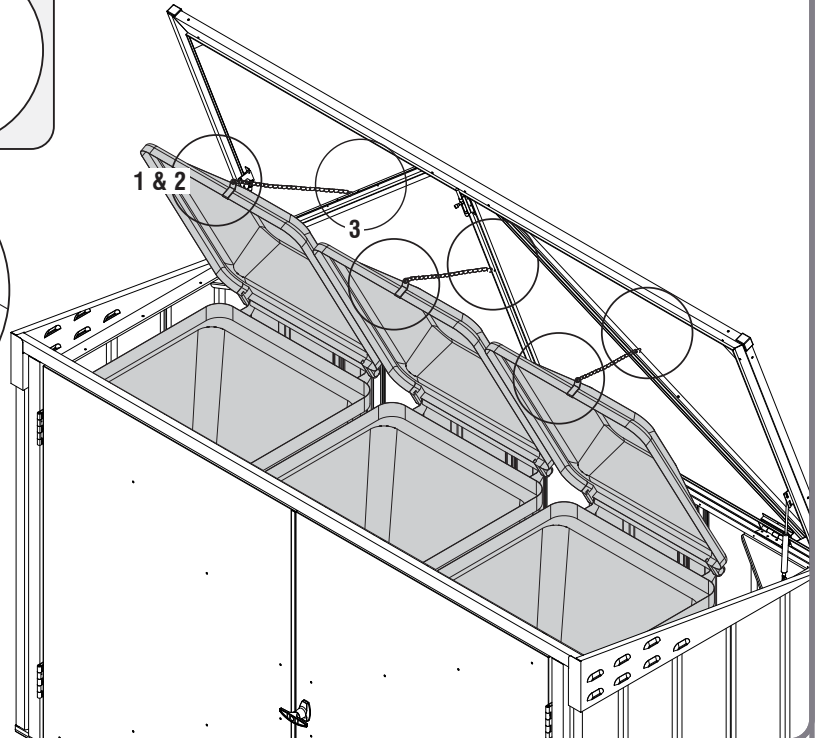
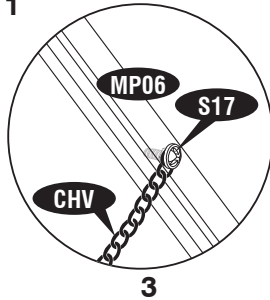
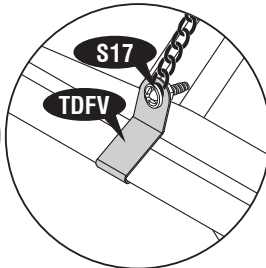
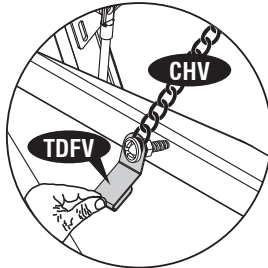
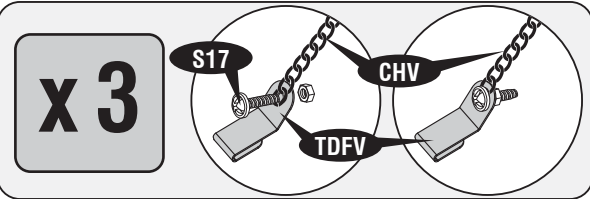
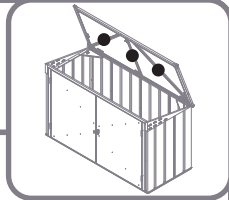



EN Fix the plastic screw cover (PC) to the screws and bolts edge from inside to prevent injury.

FR Fixer le couvercle à vis en plastique (PC) à la pointe de vis et de boulons à l'intérieur pour prévenir les accidents.

DE Befestigen Sie die Kunststoffschraubenbedeckung (PC) an das Ende der Schrauben und Bolzen von innen, um Verletzungen zu verhindern.

ES Ponga los tornillos de plástico (PC) desde el interior de la caseta para prevenir heridas.

PT Fixar as coberturas plásticas (PC) em todos os parafusos e porcas para prevenir lesões.

NL Op de plastic schroefdoppen (PC) op de schroeven en bouten om verwondingen te vermijden.

CS Nasadte plastové kryti šroubu(PC), aby zabránit případným zraněním.

SK Položte umelé kryty na skrutky (PC) a šraubky z vnútornej strany, aby ste predišli úrazu.

SL Pritrdite plastične pokrove za vijake (PC) na vijake in robove sornikov z notranje strani, da preprečite telesne poškodbe.

HR Popravite plastični poklopac vijak (PC) do vijaka i matica rub od unutra za sprječio ozljede..

HU Helyezze fel a (PC) műanyag csavarfedeleket a csavarokra belülről, a sérülések elkerülése érdekében.

SV Sätt fast plastskruvskyddet (PC) på skruvarna och bultändarna från insidan för att förebygga skada.

IT Fissa la copertura per le viti in plastica (PC) alle viti e alle estremità dei bulloni per prevenire danni e ferite.

PL Aby zapobiec zranieniu, zainstaluj plastikowe nakrętki (PC) na końce śrub i wkrętów od wewnątrz.

RO Fixați protecția de plastic a șuruburilor (PC) pe marginea șuruburilor și bolțurilor din interior pentru a preveni accidentarea.

BG Завийте пластмасовите капачки, скриващи винтовете (PC) до краищата на болтовете и винтовете от вътрешната страна, за да избегнете наранявания.

TR Herhangi bir kazayı önlemek için, plastik kapağı (PC) içeriden vida ve pulların köşelerine sabitleyiniz.

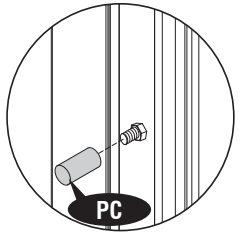
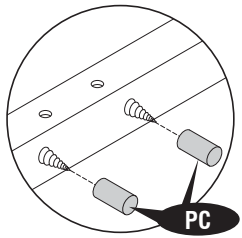

EN "For dismantling the Shed, Customer has to follow instructions manual in reverse direction."

FR " Pour le démantèlement du hangar, client doit suivre le manuel d'instructions dans le sens inverse."

DE In Gebieten mit starken Schneefällen oder starkem Wind empfehlen wir das nachstehende Zubehör.

ES "Para el desmantelamiento de la nave, cliente tiene que seguir instrucciones en sentido contrario".

PT "Para desmontar o galpão, cliente tem de seguir o manual de instruções em sentido reverso".

NL "Voor de ontmanteling van de schuur, klant heeft te volgen instructiehandleiding in omgekeerde richting."

CS 'Pro demontáž přístřešku musí zákazník postupovat podle pokynů v opačném směru.'

SK 'Pri demontáži prístrešku musí zákazník postupovať podľa pokynov v opačnom smere.'

SL 'Za demontažo skladišča mora naročnik slediti priročniku v obratni smeri.'

HR 'Za demontažu zida, korisnik mora slijediti priručnike za upute u obrnutom smjeru.'

HU 'A fészter lebontásához az Ügyfélnek vissza kell követnie az utasításokat.'

SV 'För att demontera Shed måste kunden följa instruktionsboken i omvänd riktning.'

IT 'Per lo smontaggio del capannone, il cliente deve seguire manualmente le istruzioni in senso inverso'..

PL do demontażu szopy, należy postępować zgodnie z instrukcją obsługi w odwrotnym kierunku

RO 'Pentru dezmembrarea Shedului, Clientul trebuie să urmeze manualul de instrucțiuni în sens invers.'

BG 'За демантиране на навеса клиентът трябва да следва инструкциите в наръчник в обратна посока.'

TR 'Shed'in sökülmesi için, Müşteri yönergeleri ters yönde takip etmelidir.'

- | | |
|---|--|
| EN ADDITIONAL ACCESSORIES AVAILABLE
(Not included) | HR DODATNI PROGRAMI RASPOLOŽIV
(nije uključeno) |
| FR ACCESSOIRES ADDITIONNELS DISPONIBLES
(non inclus) | HU TOVÁBBI MEGVÁSÁROLHATÓ TARTOZÉKOK
(nem tartozék) |
| DE WEITERES ZUBEHÖR
(Nicht enthalten) | SV YTTRELLIGARE TILLGÄNGLIGA ACCESSOARERV
(ingår ej) |
| ES ACCESORIOS ADICIONALES DISPONIBLES
(no incluida) | IT ACCESSORI SUPPLEMENTARI DISPONIBILI
(non incluso) |
| PT ACESSÓRIOS ADICIONAIS DISPONÍVEIS
(não incluído) | PL DOSTĘPNE DODATKOWE AKCESORIA
(nie wliczone) |
| NL EXTRA ACCESSOIRES AANWEZIG.
(niet inbegrepen) | RO ACCESORIILE SUPLIMENTARE DISPONIBILE
(Nu este inclus) |
| CS MOŽNÉ DALŠÍ DOPLŇKY.
(není součástí balení) | BG ДОПЪЛНИТЕЛНИ НАЛИЧНИ АКЕСОАРИ
(не е включен) |
| SK DOSTUPNÉ DODATOČNÉ PRÍSLUŠENSTVO
(nie je súčasťou balenia) | TR EK AKSESUARLAR MEVCUTTUR
(dahil değildir) |
| SL RAZPOLOŽLJIVA DODATNA OPREMA
(niso vključene) | |



- EN** These accessories are required in case of heavy snow or high wind areas. Please choose relevant accessories according to your needs.
- FR** Ces accessoires sont exigés en cas de zones de la neige forte ou du vent fort. Veuillez choisir les accessoires appropriés selon vos besoins.
- DE** In Gebieten mit starken Schneefällen oder starkem Wind empfehlen wir das nachstehende Zubehör.
- ES** Estos accesorios son requeridas en caso de fuertes nevadas o zonas de alto viento. Por favor, elija los accesorios pertinentes de acuerdo a sus necesidades.
- PT** Estes acessórios são necessários em áreas de vento forte e/ou neve. Por favor, escolha os acessórios pertinentes de acordo com suas necessidades.
- NL** Deze accessoires zijn nodig in geval van hevige sneeuw val of gebieden waar het hard waait. Gebruik de accessoires die u nodig heeft.
- CS** Tyto doplňky se vyžadují v místech s velkým množstvím sněhu či silným větrem. Zvolte si prosím příslušné doplňky podle vašich potřeb.
- SK** Toto príslušenstvo sa vyžaduje v prípadoch ťažkého a veľkého množstva snehu alebo silného vetra. Vyberte si relevantné príslušenstvo na základe vašich potrieb.
- SL** Ta dodatna oprema se uporablja v primeru velike količine zapadlega snega ali če lopa stoji na zelo vetrovnem območju. Izberite ustrezno opremo glede na to, kaj dejansko potrebujete.
- HR** Ovi dodaci su potrebni u slučaju teškog snijega ili jak vjetar regija. Molimo odaberite relevantne dodatne opreme prema vašim potrebama.
- HU** Ezekre a tartozékokra sürű havazás esetén vagy erősen szeles területeken van szükség. Kérjük, igénye szerint válasszon a megfelelő tartozékok közül.
- SV** Dessa accessoarer behövs vid tung snö eller i områden med hård vind. Var god välj relevanta accessoarer efter behov.
- IT** Questi accessori sono importanti in caso di neve o aree soggette a forti venti. Per favore, scegli questi accessori in base ai tuoi bisogni.
- PL** Akcesoria te są wymagane w przypadku terenów, na których zdarzają się duże opady śniegu lub silnewiatry. Wybierz odpowiednie akcesoria w zależności od potrzeb.
- RO** Aceste accesorii sunt necesare în cazul în cazul în care apar depuneri masive de zăpadă sau în zonele în care bate vânt puternic. Vă rugăm alegeți accesorii potrivite nevoilor dumneavoastră.
- BG** Тези аксесоари се изискват в случай на тежък сняг или при райони със силен вятър. Моля подберете съответните аксесоари според нуждите.
- TR** Bu aksesuarlar yoğun kar yağışı ya da kuvvetli rüzgar alan bölgelerde gereklidir. Lütfen ihtiyaçlarınıza uygun gerekli aksesuarları seçiniz.

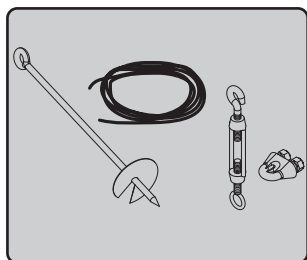

1

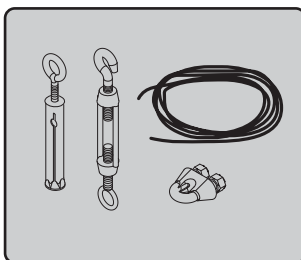

2

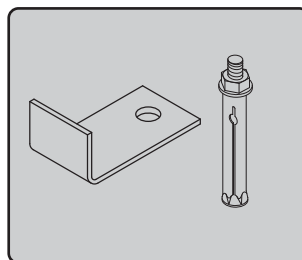

3

1

- | | |
|------------------------------------|--------------------------------|
| EN ANCHOR KIT (Soil) | HR SIDRO KOMPLET (tla) |
| FR KIT D'ANCRE (Sol) | HU RÖGZÍTŐ FELSZERELÉS (Talaj) |
| DE ANKER-KIT (Boden) | SV FÖRANKRINGS-KIT (Jord) |
| ES KIT DE ANCLAJE (Suelo) | IT KIT DI ANCORAGGIO (Suolo) |
| PT KIT DE APOIO (Solo) | PL ZESTAW DO MOCOWANIA (Grunt) |
| NL ANKER GEREEDSCHAP (bodem) | RO SET DE ANCORARE (ÎN SOL) |
| CS KOTEVNÍ SOUPRAVA (Hlína) | BG КОМПЛЕКТ АНКЕРИ (Почва) |
| SK UKOTVOVACIE PRÍSLUŠENSTVO (zem) | TR EKLEMLEME KİTİ (Toprak) |
| SL SIDRNA OPREMA (zemlja) | |

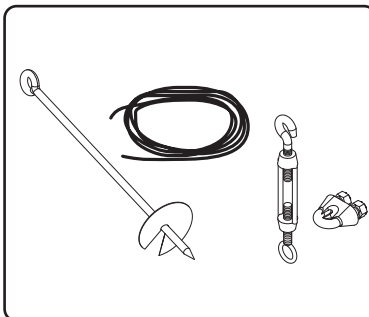

- EN** Wire rope with twist augers for sheds installed with foundation (Wood / Metal) on soil.
For heavy wind area.
- FR** Fil de fer avec des foreuses de torsion pour des hangars installés avec la base (en métal / en bois) sur le sol. **Pour la zone du vent fort.**
- DE** Seil mit Erdbohrer bei einem Unterbau (Holz / Metal) auf dem Boden.
Für Gebiete mit starkem Wind.
- ES** El cable metálico para casetas instaladas con kit de estructura de suelo fijada al hormigón.
Para el área del fuerte viento.
- PT** Cabo metálico com brocas para galpões instalados com base (Madeira/Metal) em solo.
Para áreas de vento forte.
- NL** Bedrading met kronkelige grondboren voor het schuurtje moet met fundering worden geïnstalleerd (hout/metaal) op bodem. **Voor hevige wind gebieden.**
- CS** Drátěné lano se vrtáky pro kůlny postavené se základy (dřevo / kov) na hlíně.
Pro místa se silným větrem.
- SK** Drôtené lano s krútenými špirálovitými šnekmi pre hangáre nainštalované zo základom (drevo/kov) na zemi. **Pre oblasti so silným vetrom.**
- SL** Žična vrv z velikim svedrom z enojno spiralo za lope nameščene na temelju (les/kovina) na zemlji.
Za zelo vetrovna območja.
- HR** čelikčelo s okretati svrdlom za baca instaliran s temelja (Drvo / Metal) na tlu.
Za teške vjetar području.
- HU** Drótkötél spirálfúrókkal alappal rendelkező kerti fészerekhez (Fa / fém) talajon.
Erősen szeles területekre.
- SV** Wirelås med tvistborr för skjul installerade med grund (trä / metall) på jord.
För områden med hård vind.
- IT** Fune con trivella a spirale per capannoni installati con fondamenta (legno/metallo) sul suolo.
Per aree soggette a forte vento.
- PL** Lina stalowa ze świdrami dla magazynków montowanych na pod stawie (Drewno/Metal) do gruntu.
Przeznaczone do użytkowania na obszarach występowania silnych wiatrów.
- RO** Cabluri cu burghie răsucite pentru magazine asamblate pe fundație (Lemn / Metal) în sol.
Pentru zonele în care bate vânt puternic.
- BG** Стоманено въже с извити сонди за заслони, монтирани върху фундаменти (Дърво / Метал) върху почва.
За силно ветровита зона.
- TR** Zemin (tahta/metal) toprak üstüne gecekler şeklinde inşa edilen barınaklar için burgulu matkap ve tel ip.
Kuvvetli rüzgar alan yerler için.

2

- | | |
|--------------------------------------|--------------------------------|
| EN ANCHOR KIT (Concrete) | HR SIDRO KOMPLET (beton) |
| FR KIT D'ANCRE (Béton) | HU RÖGZÍTŐ FELSZERELÉS (Beton) |
| DE Verankerungsset (Beton) | SV FÖRANKRINGS-KIT (Betong) |
| ES KIT DE ANCLAJE (hormigón) | IT KIT DI ANCORAGGIO (cemento) |
| PT KIT DE APOIO (Concreto) | PL ZESTAW DO MOCOWANIA (Beton) |
| NL ANKER GEREEDSCHAP (Beton) | RO SET DE ACORARE (Beton) |
| CS KOTEVNÍ SOUPRAVA (Beton) | BG КОМПЛЕКТ АНКЕРИ (Бетон) |
| SK UKOTVOVACIE PRÍSLUŠENSTVO (betón) | TR EKLEMLEME KİTİ (Beton) |
| SL SIDRNA OPREMA (beton) | |

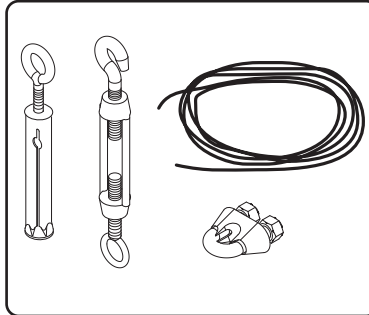

- EN** Eye bolt with wire rope for sheds installed with foundation (Wood / Metal) on concrete.
For heavy wind area.
- FR** OEil à queue filetée avec fil en fer pour des hangars installés avec la base (en métal / en bois) sur le béton.
Pour la zone du vent fort.
- DE** Ringschraube mit Seil für Gerätehäuser mit einem Unterbau (Holz / Metal) auf Beton.
Für Gebiete mit starkem Wind.
- ES** Coloque pernos de ojo y el cable metálico para las zonas de fuerte viento.
Para el área del fuerte viento.
- PT** Cavilha com cabo de aço para galpões instalados com base (Madeira/Metal) em concreto.
Para áreas de vento forte.
- NL** Eyebolt met stalendraad voor schuurtje moet worden geïnstalleerd met fundering (hout/metaal) op beton.
Voor hevige wind gebieden.
- CS** Oka s drátěným lanem pro kůlny postavené se základy (dřevo / kov) na betonu.
Pro místa se silným větrem.
- SK** Šrob s okom s drôteným lanom pre hangáre nainštalované so základom (drevo/kov) na betóne.
Pre oblasti so silným vetrom.
- SL** Očesni vijak z žično vrvjo za lope nameščene na temelju (les/kovina) na betonu.
Za zelo vetrovna območja.
- HR** oči vijak žičane užadi za baca Installer sa temelja (Drvo / Metal) na betonu.
Za teške vjetar području.
- HU** Gyűrűs csavar drótkötéllal alappal rendelkező kerti fészerekhez (Fa / fém) betonon.
Erősen szeles területekre.
- SV** Stagöglå med wirelås för skjul som installerats med grund (Trä / Metall) på betong.
För områden med hård vind.
- IT** Vite ad occhio con fune per capannoni installati con fondamenta (legno/metallo) sul cemento.
Per aree soggette a forte vento.
- PL** Śruba z uchem z liną stalową dla magazynków montowanych na podstawie (Drewno/Metal) do betonu.
Przeznaczone do użytkowania na obszarach występowania silnych wiatrów.
- RO** Șurub cu ochi atașat la un cablu pentru magaziiile asamblate pe fundație (Lemn / Metal) în beton.
Pentru zonele în care bate vânt puternic.
- BG** Шарнирен болт със стоманено въже за заслони, инсталирани с фундамент (Дърво / Метал) върху бетон.
За силно ветровита зона.
- TR** Zemin (tahta/metal) beton üstüne gelecek şekilde inşa edilen barınaklar için halkalı vida ve tel ip.
Kuvvetli rüzgar alan yerler için.

3

- | | |
|---------------------------------------|-----------------------------------|
| EN ANCHOR KIT (Foundation) | HR SIDRO KOMPLET (Temelj) |
| FR KIT D'ANCRE (Base) | HU RÖGZÍTŐ FELSZERELÉS (Alap) |
| DE ANKER-KIT (Fundament) | SV FÖRANKRINGS-KIT (Grund) |
| ES KIT DE ANCLAJE (Fundación) | IT KIT DI ANCORAGGIO (Fondamenta) |
| PT KIT DE APOIO (Base) | PL ZESTAW DO MOCOWANIA (Podstawa) |
| NL ANKER GEREEDSCHAP (Fundering) | RO SET DE ACORARE (Fundatie) |
| CS KOTEVNÍ SOUPRAVA (Základy) | BG КОМПЛЕКТ АНКЕРИ (Фундамент) |
| SK UKOTVOVACIE PRÍSLUŠENSTVO (základ) | TR EKLEMLEME KİTİ (Zemin) |
| SL SIDRNA OPREMA (temelj) | |

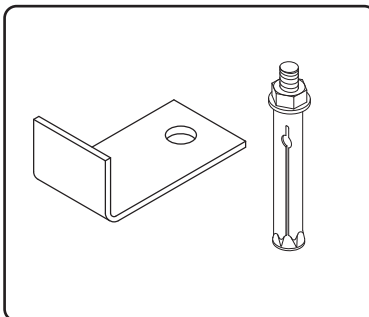

- EN** Strap clamping for shed assembly with foundation (Wood / Metal) on concrete.
To prevent shed from displacement.
- FR** Encastrement pour le hangar avec la base (en métal / en bois) sur le béton.
Pour empêcher le hangar du déplacement.
- DE** Ankerbolzen für Gerätehäuser mit einem Unterbau (Holz / Metal) auf Beton.
Um ein Verschieben des Gerätehauses zu vermeiden.
- ES** Correa de sujeción para el correcto montaje sobre la cimentación (madera u hormigón).
- PT** Cinta de fixação para montagem do galpão com base (madeira/ metal) em concreto
Para evitar deslocamento do galpão.
- NL** Klemband voor montage van schuurtje met fundering (hout/metaal) op beton.
Voorkom het schuurtje van verschuiven.
- CS** Připevnění pro kůlny postavené se základy (dřevo / kov) na betonu.
K prevenci pohybu kůlny.
- SK** Zvieranie popruhu, resp. zvierací popruh pre hangáre zostavené so základom (drevo/kov) na betóne.
Na zabránenie premiestnenia hangáru.
- SL** Jermena za pritrdjevanje lope nameščene na temelju (les/kovina) na betonu.
Za preprečevanje premika lopa.
- HR** Privezati kaišem za proliše stezanja montaža s temeljem (Drvo / Metal) na betonu.
Da biste spriječili prolivena od pomaka.
- HU** Szorítócsavar az alappal rendelkező kerti fészter összeszereléséhez (Fa / fém) betonon.
Megakadályozza a kerti fészter elmozdulását.
- SV** Spänn fast skjulmontage vid grunden (Trä / Metall) på betong.
För att förebygga förskjutning.
- IT** Cinghia di bloccaggio per l'assemblaggio del capannone con fondamenta (legno/metallo) sul cemento.
Per evitare un disassamento del capannone.
- PL** Lina stalowa ze świdrami dla magazynków montowanych na pod stawie (Drewno/Metal) do gruntu.
Przeznaczone do użytkowania na obszarach występowania silnych wiatrów.
- RO** Curea de prindere pentru magazinele asamblate pe fundație (Lemn/Metal) în beton.
Prevenirea deplasării magaziei.
- BG** Затягане с връзка за сглобяване на заслон с фундамент (Дърво / Метал) върху бетон.
За да предпазите заслона от изместване.
- TR** Zemin (tahta/metal) beton üstüne gelecek şekilde inşa edilen barınaklar için mengene.
Barınağın kaymasını engellemek için.



U.S. Polymers, Inc.
1057 S. Vail Ave
Montebello, CA 90640,
United States of America

www.duramaxbp.com